



*The absolute opposite of ordinary*

## **G814 Quad Channel Edge Blender User Guide**

***Max. Input: 4096\*2160 @60Hz 4:4:4, 7680\*1200 @30Hz***

***Max. Output: 2048\*1080 @60Hz 4:4:4***

***New generation Warp & Edge blending***

***Full functions in one box, simple, reliable***

***No PC required***



E-mail: [sales@vnstw.com](mailto:sales@vnstw.com)

Tel: +886-2-2792-2819    Mobile: +886-935-678-033

Skype: Geobox-Taiwan

Version: 2.00

Website: [www.vnstw.com](http://www.vnstw.com)

## Table of Contents

Disclaimer/Copyright Statement.....	3
Warranty/RMA.....	3
FCC/CE Statement.....	3
Introduction.....	4
Functions and Features.....	5
<b>1. Content in the packing box.....</b>	<b>8</b>
<b>2. Basic operation &amp; settings</b>	
2.1. System structure, input ports and output ports.....	8
2.2. System connection.....	10
2.3. LED indicators.....	11
2.4. Signal Connection and Power On.....	11
2.5. HDMI Loop Out for daisy chain connection.....	12
2.6. System Settings: Box ID, RS232, Ethernet.....	13
2.7. How to use IR Remote Controller.....	14
2.8. OSD Lock and unlock in multi-unit application .....	15
2.9. Full screen and native aspect ratio.....	16
2.10. Image rotation and flip.....	16
2.11. System Power on sequence.....	16
2.12. Color adjustment.....	17
2.13. System synchronization.....	18
2.14. System Reset.....	19
2.15. System image aspect ratio adjustment.....	19
<b>3. Preparation for edge blending</b>	
3.1. Determine source signal resolution.....	21
3.2. Determine overlap region size and pixels.....	21
3.3. Relation between Overlap pixels and geometry alignment accuracy.....	22
3.4. Get installation data from VNS Excel Spread Sheet.....	24
3.5. Apply Spread Sheet data for projector installation and GeoBox setting.....	25
3.6. Projector settings before edge blending.....	26
3.7. GeoBox settings before edge blending.....	27
<b>4. Geometry Alignment</b>	
4.1. Select the right Grid Pattern for geometry alignment.....	27
4.2. Grid pattern pixel size selection.....	28
4.3. Geometry alignment.....	29
4.3.1. Geometry alignment through remote controller.....	30
4.3.2. Activate grid pattern.....	30
4.3.3. [2x2] 4 corner geometry alignment.....	31
4.3.4. [3x3], [5x3], [9x5] · [17x9] warp alignment.....	31
4.3.5. Linearity grid line adjustment.....	33
4.3.6. “W” shape Corner [Wall] geometry adjustment.....	34
4.3.7. Important notice on curved screen display.....	36
4.4. Geometry alignment via GCT PC Tool.....	37
<b>5. [Video Wall] settings.....</b>	<b>39</b>
5.1. [Zoom]: split the signal source.....	39
5.2. [Pan]: assign image location.....	40
5.3. [Overlap]: crop the right image for each projector.....	40

---

5.4. [Position]: shift image position without changing image size.....	41
<b>6. [Edge Blend] settings</b> .....	42
6.1. [Edge] selection location and set edge blending value.....	43
6.2. [Shift]: shift image position and execute Edge Mask.....	43
6.3. [Gamma]: color correction in edge blending area.....	44
6.4. Black level uplift: [Offset] & [Corner] adjustment.....	46
6.5. [Color]: Individual projector white balance and color correction.....	50
6.6. Edge [Mask].....	50
6.7. [Grid] (determine grid patten size) .....	52
6.8. Final image quality fine-tuning.....	52
<b>7. Example for 3 projector edge blending procedures</b> .....	54
7.1. Get detailed edge blending information through VNS Excel Spread Sheet.....	54
7.2. Mark image location and install the projectors.....	55
7.3. System connection.....	55
7.4. Projector settings.....	56
7.5. GeoBox settings.....	56
7.6. Geometry alignment.....	57
7.7. Video wall settings.....	59
7.8. Edge blending setting.....	60
7.9. Final image quality fine-tuning.....	61
<b>8. Save/Load system settings</b> .....	62
<b>9. Multiple unit applications</b> .....	
9.1. System connection in multiple unit edge blending.....	63
9.2. Content overlap setting issue .....	65
9.3. Convenient setting in multiple unit application.....	66
9.3.1. Setup by remote controller.....	66
9.3.2. Setup by Ethernet.....	66
<b>10. WebGui and GCT PC tool</b> .....	67
10.1. WebGui .....	67
10.2. GCT PC Tool .....	68
<b>11. Advanced applications and settings</b> .....	76
11.1. Passive 3D application.....	76
11.2. Active 3D application.....	78
11.3. Multiple Wall Immersive display.....	78
11.4. Portrait edge blending.....	81
11.5. Flexible display.....	82
11.6. Discrete content displayed in each projector.....	83
<b>12. System structure and control</b> .....	
12.1. System structure.....	84
12.2. OSD command executing in both modules at the same time.....	84
12.3. OSD command executing in each processing module.....	84
<b>13. Miscellaneous settings</b> .....	
13.1. Helpful tips for edge blending.....	86
13.2. Image distortion.....	86
13.3. EDID settings.....	87
13.4. HDMI vs. DVI output signal.....	88
13.5. System standby and automatically turn off output signal.....	89
13.6. Change background color.....	89

13.7. Turn off Splash screen Logo.....	89
13.8. Limitation in image flip and rotation.....	90
<b>14. Trouble shooting</b>	
14.1. Front panel LED indicators.....	90
14.2. No image in the projector.....	90
14.3. Intermittent or loss of input signal.....	90
14.4. Video quality issues.....	91
14.5. Image position shift after installation.....	92
14.6. System crash and malfunction .....	92
14.7. Synchronization issue in the outputs.....	93
14.8. How to reduce projector re-searching input signal.....	93
<b>15. Technical support</b> .....	93
<b>16. Safety precaution and maintenance</b> .....	94
<b>Specification</b> .....	95
<b>Revision History</b> .....	97

**Disclaimer/Copyright Statement**

Copyright 2023, VNS Inc. All Right Reserved

This information contained in this document is protected by copyright. All rights are reserved by VNS Inc. VNS Inc. reserves the right to modify this document without any obligation to notify any person or entity of such revision. Copying, duplicating, selling, or otherwise distributing any part of this document without signing a non-disclosure agreement with an authorized representative of VNS Inc. is prohibited. VNS Inc. makes no warranty for the use of its products and bears no responsibility for any error of omission that may appear in this document.

Product names mentioned herein are used for identification purposes only and may be trademarks of their respective companies.

**Limited Warranty and RMA statement**

This device is designed and tested to the highest standards and backed by two years’ parts and labor warranty. Warranties are effective upon the first delivery date to the end customer and are non-transferable. Warranty related repairs include parts and labor, but do not include repair of faults resulting from user negligence, special modifications, abuse (mechanical damage), shipping damage, and/or other unusual damages. The customer shall pay shipping charges when the unit is returned for repair. Manufacturer will pay shipping charges for return shipments to customers.

Manufacturer does not assume responsibility for consequential damages, expenses or loss of revenue, inconvenience or interruption in operation experienced by the customer. Warranty service shall not automatically extend the warranty period.

User can pay extension fee to extend the warranty period. Please contact us for more details. In the event that a product needs to be returned for repair, inform manufacturer and ask for a Return Material Authorization number.

**FCC/CE statement**

Note: This equipment has been tested and found to comply with the limits for a Class A digital device, pursuant to Part 15 of FCC Rules. These limits are designed to provide reasonable protection against harmful interference in a residential installation. This equipment generates, uses and can radiate radio frequency energy and, if not installed and used in accordance with the instruction, may cause harmful interference to radio communications. However, there is no guarantee that interference will not occur in a particular installation. If this equipment does cause harmful interference to radio or television reception, which can be determined by turning the equipment off and on, the user is encouraged to try to correct the interference by one or more of the following measures:

- Reorient or relocate the receiving antenna.
- Increase the separation between the equipment and receiver.
- Connect the equipment into an outlet on a circuit different from that to which the receiver is connected.
- Consult the dealer or an experienced radio/TV technician for help.

Notice:

- (1) An Unshielded-type power cord is required in order to meet FCC emission limits and also to prevent interference to the nearby radio and television reception. It is essential that only the supplied power cord be used.
- (2) Use only shielded cables to connect I/O devices to this equipment.
- (3) Changes or modifications not expressly approved by the party responsible for compliance could void the user’s authority to operate the equipment.

## Introduction

G814 is designed with sophisticated edge blending as well as image warping, stacking, projection mapping...etc. It consists of two G812 processing modules and can serve as dual G812 function for 4 projector edge blending.

8 inputs (4x HDMI, 2x DP, 2x VGA) and 4x HDMI outputs are designed in G814. Input supports up to 7680\*1200 @30Hz, 4096\*2160 @60Hz with 4:4:4 full color sampling. Output supports up to 2048\*1080 @60Hz. It is integrated with 10-bit high end processor, motion adaptive de-interlace, low angle smooth algorithm, 3:2/2:2 pull-down and supports non-VESA standard input timing for connecting with various input sources. Any input signal can be fed to dual channels in that processing module at the same time.

Advanced warp technology is embedded in G814. User can perform sophisticated geometry alignment and curved screen edge blending through remote controller, WebGui, USB or Ethernet. Maximum geometry control point is 17x9 grids with 120x68 pixel position fine-tune. Linearity Grid Line Adjustment and "W" type Corner Wall image adjustment for mapping image at 90 degrees or square corner pillar is a new function in geometry alignment. Separate RGB gamma correction for edge blending color fine-tune, individual color correction for each output, fine pixel color uniformity and 9 regions non-edge blending area black level uplift are also embedded in G814. Users can see real time geometry and colour adjustment to get optimized result.

HDMI 2.0 loop out supports daisy chain connection up to 7680\*1200 @30Hz and allows large display with multiple units cascaded. Video wall function in G814 is to crop and allocate source image for each projector and set overlap pixels for edge blending. Complete curved screen edge blending can be achieved through remote controller or Ethernet without PC software, video distributor and splitter.

G814 is designed to support programmable EDID and non-VESA standard input. User can create any EDID timing in the range between 1024x768 and 3840x2400 in order to optimize video performance.

Using G814, users can replace high end projector with low-cost projector without lens shift, warp and edge blending. It provides easy configuration, low entry barrier, cost effective, reliable and flexible solution.

Dual power supply system is embedded in G814. User can use either AC power 100V-240V power supply or DC 12V 2A power supply with external DC 12V power adapter. When apply AC power supply, user will have one DC 12V 1A output for signal extender. Standard delivery will be packed with AC power cord.

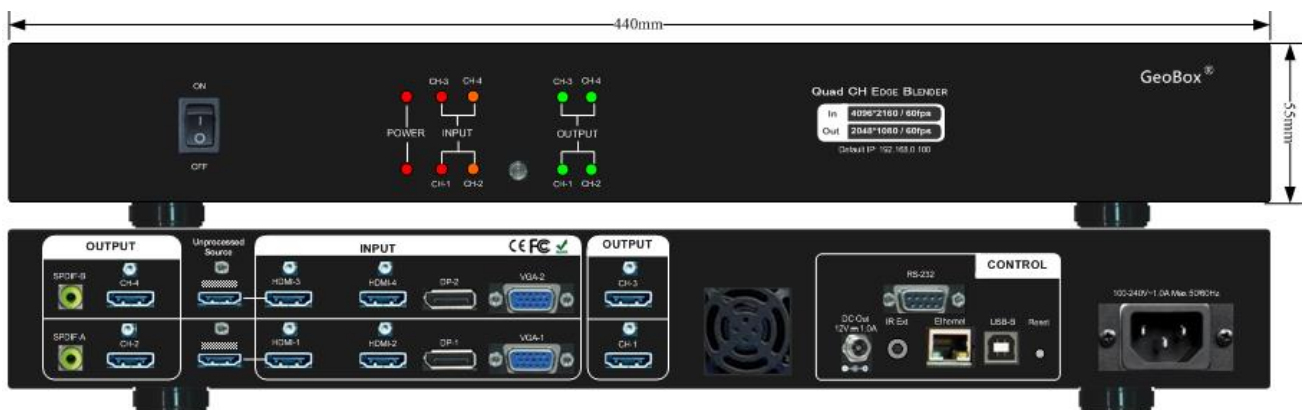

---

## **Functions and features**

### **A. Input and output:**

- G812: single processing model, G814: dual processing modules.
- Each processing module has below input and output ports:
  - ✓ Input ports: 2x HDMI, 1xVGA, 1x DisplayPort.
  - ✓ HDMI & DisplayPort support 4096\*2160 @60Hz, 3840\*2400 @60Hz with 4:4:4 sampling without compression. VGA supports up to WUXGA or 205MHz analog input signal.
  - ✓ Connect with various video sources and support none VESA standard input resolution.
  - ✓ Output ports: 2x HDMI. Selectable output resolutions: XGA, WXGA, 1280x720, 1280x1024, 1366x768, 1920x1080 (24/30/50/60Hz), 1920x1200 (30/60Hz), 2048x1080/60, 1024x768 @120Hz, 1280x720 @120Hz, 1280x800 @120Hz.
  - ✓ Loop out port: 1x HDMI 2.0b (supports 4096x2160@60Hz & 7680x1200@30Hz)

### **B. Image warp and geometry alignment**

- Selectable grid pattern size for geometry alignment from 8-120 pixels in H&V. Default size is 32\*32 pixels.
- With full functions for quick 4 corner alignment, vertical and horizontal keystone correction, Pincushion & Barrel adjustment, image warp and image 90/180/270 degrees rotation and flip.
- Warp engine for geometry alignment up to 17\*9 & 120x68 control points in IR control and PC Tool.
- 120x68 grid pixel position fine-tune. Each control point can be adjusted with 1/4 pixel/step and moved up to 12.5 pixels adjustment range. Maximum adjusting points are 100 points.
- Geometry alignment range (4 corners + warp adjustment) is up to H=+\_ 1200 pixels and V=+\_ 1200 pixels in full HD output.

### **C. Linearity Grid Line Adjustment**

- Support Linearity Grid Line adjustment for quick H&V line position alignment.
- This function can be implemented together with 3x3, 5x3, 9x5 and 17x9 warp alignment.

### **D. “W” shape Corner Wall Alignment**

Support “W” type Corner Wall adjustment in horizontal and V type in vertical direction. The maximum adjusting range is 1200 pixels.

### **E. Simultaneously PC Tool and IR controller setup**

PC Tool and IR controller can work simultaneously and swap operation at any time. The result will be executed into the Box at real time.

## F. Edge blending

- Four direction edge blending up to H=1920, V=1200 overlapped pixels for flat, curved & cylindrical screens.
- Independent RGB gamma selection for edge blending color fine.
- White balance and individual color correction for each projector.

## G. Black Level Uplift

Precise black level uplift at multiple selected areas up to 9 regions to compensate light leakage in the projector. Low native contrast ratio projector will be more serious in light leakage.

## H. Edge mask

Image [Shift] to execute edge mask up to 500 pixels following the image profile after geometry adjustment and [Edge Mask] with 8 adjustment points to provide irregular shape edge mask with random edge position up to 900 pixels in each control point. These two functions can be executed at the same time.

## I. High end 10-bit video processing

- 10-bit high end processor with 3D motion adaptive de-interlace, low angle smooth algorithm and 3:2/2:2 film mode detect and recovery function.
- Complete color adjustment function, including brightness, contrast, hue, saturation, preset color mode, independent RGB gain adjustment and white balance correction.

## J. Video Wall function

- Image cropping and location assignment for each projector.
- Image pixel cropping range is up to +\_1800 pixels for image position shift, aspect ratio adjustment, bezel compensation and creating overlap region for edge blending.
- Serve as video wall controller for irregular video wall display up to 15x15 matrix displays from single signal source.

## K. Image rotation and flip

- Image 90/180/270 degrees rotation, flip and mirror up to 4k/30Hz input resolution.
- Image flip in Front/Rear, Left/Right and Top/Bottom directions.
- When execute 90/270 degrees image rotation, no PIP/POP function is available.
- No 3D motion adaptive de-interlace function while the image is 90/270 degrees rotated. We propose to apply progressive signal source to get the best video quality.

## L. Decode 3D signal for passive 3D display

Support side by side and top/bottom 3D input signal. After warp and edge blending, output RH/LH eye frames signals for passive 3D display.

## M. Background color adjustment

White balance and individual color correction for each output channel.

## N. System control and other features

- Full function operation by front panel keypad, WebPage, IR and Ethernet (Including through WiFi by PC, Mobile or iPad).
- Firmware update via USB or Ethernet.
- GCT PC tool can control multiple processors simultaneously through USB or Ethernet.
- Internal grid pattern with selectable color and grid size for easy geometry alignment.
- RS232 & Ethernet control system compatible with most of control system.
- User can select blue or black background color when no input signal is detected.
- Programmable EDID in the range at H=1024~3840, V=720~2400.
- BOX ID and programmable IP address for convenient multiple unit control at the same time.
- User can save up to 5 settings and can be recalled by IR controller, RS232, USB or network.
- System settings can be backup in PC, USB device and copied to another unit.
- Automatic power ON/OFF through input signal control. While no input signal is detected, it will shut down output automatically. User can power ON/OFF the system through the control in signal source.

## 1. Content in the packing box

- The G814 Quad Channel Video Wall Controller
- 1x RC-400 IR Remote Controller
- 1x IR Extending Receiver with 1.8m cable
- 1x AC Main Power Cord
- Mounting bracket with screw (Option)
- Please download User Guide & GCT PC Tool at [www.vnstw.com](http://www.vnstw.com)

## 2. Basic operation & setting

### 2.1. System structure, input ports and output ports

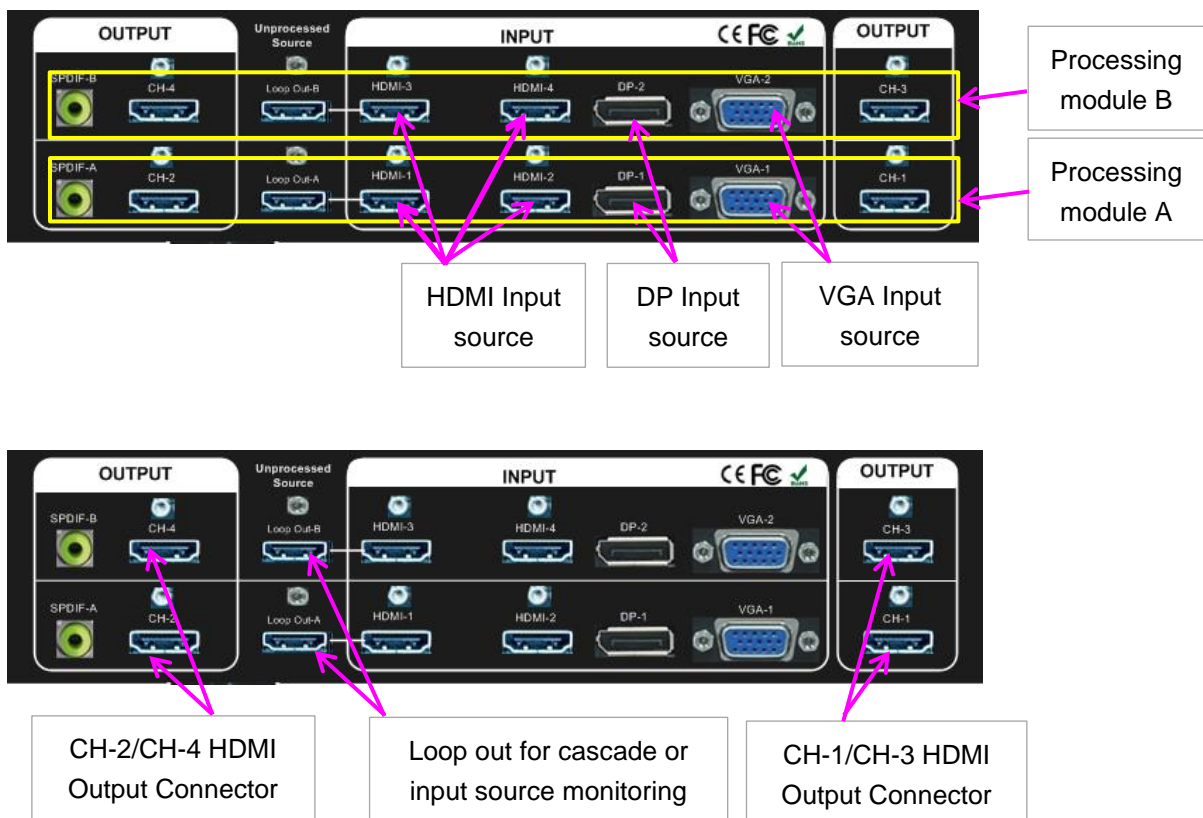

- G814 consists of two G812 processing modules. It can be treated as one 4 channel processor or two dual channel processors.
- Processing module A & B are independent. The input signals in each module are only for that processing module and can't share to another processing module.
- User can select different contents for each processing module or each output channel.

- HDMI & DP input ports support up to 4096x2160 @60 Hz and 8k/1k @30Hz.
- Only HDMI-1 & HDMI-3 input signals can be looped out. Loop out signal is unprocessed signal. User needs to connect one Loop out signal to the second processing module HDMI input port while executing quad channel edge blending or more unit cascade application.
- User can select different input sources for each projector to display separate contents in four projectors. However, only one HDMI input signal can be selected in each processing module. Another signal shall be selected from DP or VGA.
- For 4 projectors edge blending application, user can connect any output to any projector and select projector location via [Video Wall]→ [Pan] menu.
- If independent content display is required, user needs to arrange the input source and output connection and let input source be displayed at specific projector.
- User can select input source through remote controller, WebGui or GCT PC tool. The selection will apply to one processing module only. User can have different IN/OUT settings in each processing module.

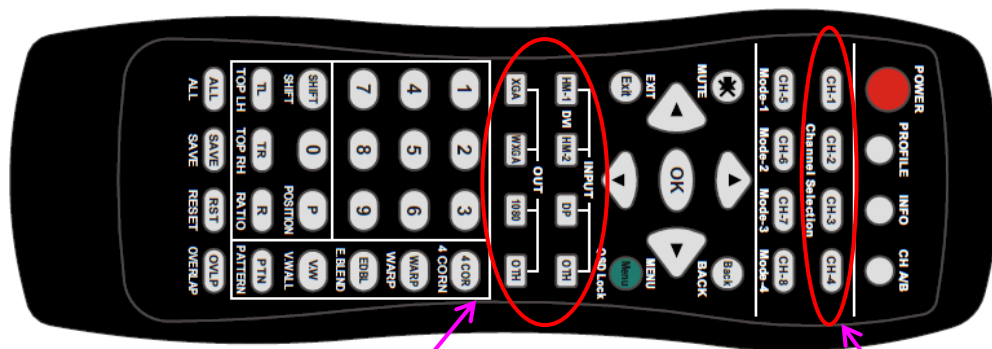

- Select CH, then select input port and output resolution.
- Output resolution will apply to two CH at the same time.

Press CH key to select operation channel.

- G814 can support non-VESA standard input timing once signal source can provide, such as 4096x2160, 3200x2400.
- The output resolution should be the same as the projector native resolution. If user changes output resolution, geometry adjustment result will also be changed.
- All output default resolution is 60Hz, RGB 4:4:4 and progressive.
- If the output refresh rate is not the same as input refresh rate. The frame lock function will be disabled and it may lose synchronization among output channels. If the input is 4k/30 with FHD/60 output, it will have no synchronization issue. If the input is 50Hz, please select 1080p 50 Hz output to avoid frame repeat issue.
- User can click [Info] key to get system information and input / output signal resolution.

## 2.2. System connection

- For one G814 application: connect the signal to HDMI-1 or HDMI-3, then daisy chain through Loop out port to HDMI port in next processing module.

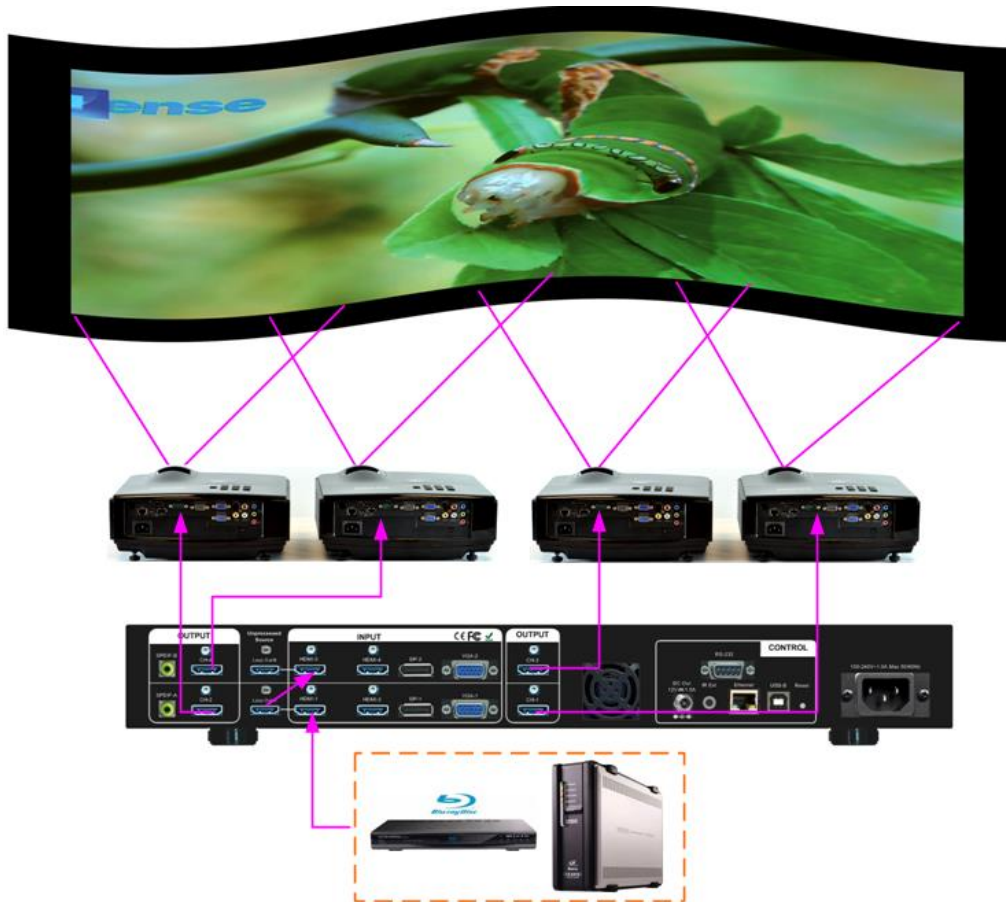

- Once input signal and output ports are properly connected, LED indicator on the front panel will show up. If any of the LED in CH-1 ~ CH-4 is not lighted up, please check the input/output connection and cable.

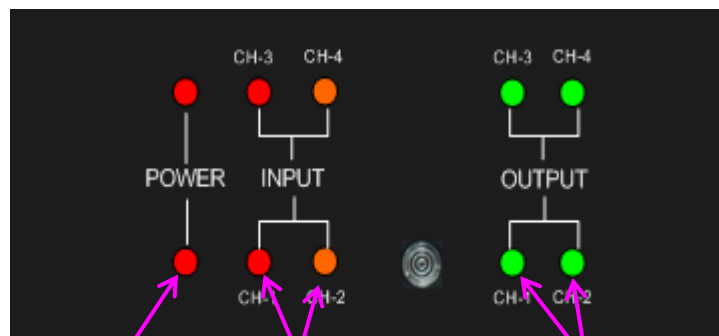

- If Power SW is on, LED will light up
- LED lights up when Input Source is detected
- LED lights up when output projector is detected.

- Multiple G814 application: connect multiple units through loop out port.

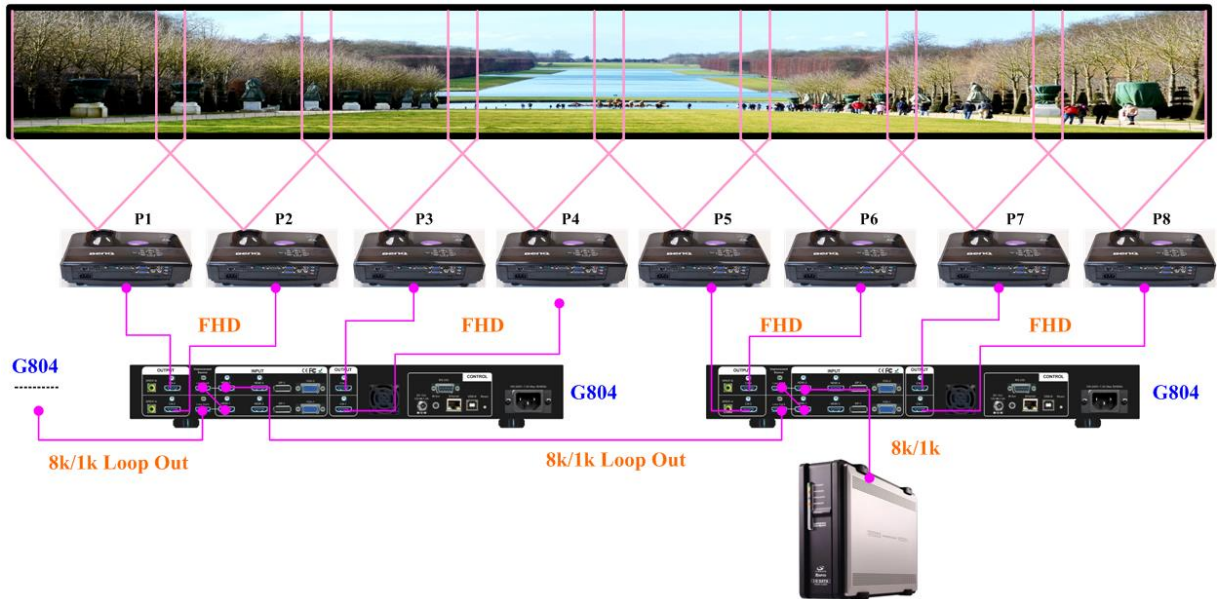

### 2.3. LED indicators

- LED indicators will show the input/output signal status.
- Green LED will show up when the input signal is detected.
- Orange LED will show up when the display device (projector) is connected.
- If user presses Menu key for 5 seconds on the remote controller, GeoBox OSD menu will be locked and the Power LED will be flashing. To press another 5 seconds, it will unlock OSD menu.
- If multiple units are used in the system, user can set different ID and use remote controller [85x] key to execute independent control. Press [851] following other OSD keys, the remote controller can only show Box ID #1 OSD and Power LED on front panel in other units will be flashing. User can disable OSD LOCK with [850] command via IR controller.

### 2.4. Signal connection and Power On

- Poor quality HDMI cable and signal source will affect the connection distance and may cause signal noise or show intermittent image.
- To ensure all cables are connected correctly, it is recommended to use locking cables.



- Complete edge blending system should be connected to one power Distribution Box with proper grounding. Power on the system after finishing all connections to avoid system damage by floating voltage among devices.
- When power is switched on G814, the booting time is about 19 seconds and the Input & Output LEDs on front panel will stay “Lighted” all the time for the channel with correct input source and output device connections.
- If continuous flashing in power LED, it means the OSD function has been Locked. Please press [Menu] key for 5 seconds to disable [OSD Locked] function. If system lock is done by remote controller through [85x] operation, please press [850] to unlock system control.

## 2.5. HDMI Loop Out for daisy chain connection

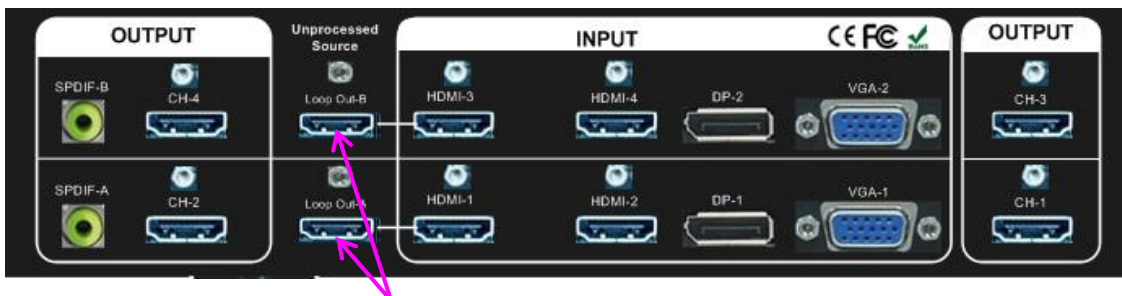

Unprocessed raw signal from HDMI Loop Out to next GeoBox or processing module HDMI input port or signal source monitoring

- Loop Out provides the same unprocessed source signal from HDMI2.0-1/HDMI-3 input port. It supports up to 4096x2160/60Hz and 7680\*1200/30Hz.
- Input signals from HDMI-2/HDMI-4, DP and VGA ports can't be looped out. If user wants to execute multi-unit edge blending through DP or VGA input ports, please add DP or VGA video distributor and feed signal to all G814 and processing modules.
- User can connect any Loop Out signal to HDMI-1 or HDMI-3 input port in next GeoBox. No specific HDMI input port is assigned.
- User can connect up to more than 5 units of G814 through daisy chain connection. The daisy chain connection number is related to the quality of HDMI cables and signal source resolution—good cable or lower source resolution can connect more units. User can also add HDMI splitter at the front end to increase the connection number for large scale video display.
- If loop out port is not connected, user can connect to a monitor for signal source monitoring purpose. HDMI Loop Out port is for daisy chain connection. It is not an input port.

## 2.6. System settings: Box ID, RS232, Ethernet

- Box ID, RS232 and Ethernet settings shall be executed through CH-1. The setting result will be applied to complete unit.
- User can control or operate G810 settings through Ethernet. Default IP address is 192.168.0.100.
- When multiple units are used at the same time, user can set different IP address in each G810 so that each G810 can be controlled independently.

### 2.6.1. Box ID

- The range of Box ID is 0 ~ 99 for RS232 command.
- If user uses remote controller to execute system operation, the Box ID range is 0 ~ 9.

### 2.6.2. RS232 settings

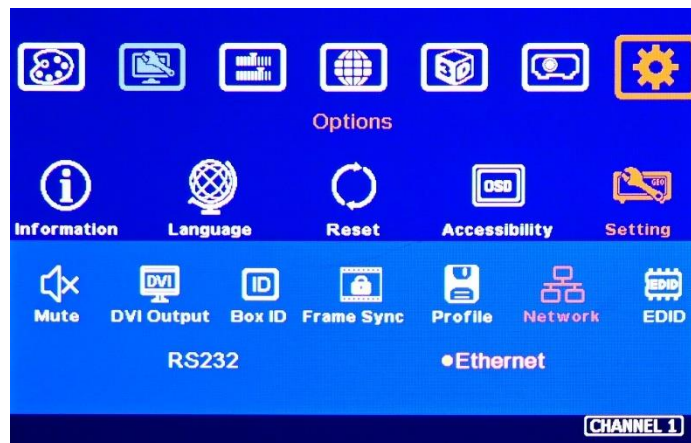

- RS232 is designed with DB-9 connector. User can select baud rate between 11520 and 9600.
- UART protocol for the control from RS-232 or Ethernet is available in the website.

### 2.6.3. Ethernet

- User needs to connect GeoBox to WiFi Router or switch/hub through RJ45 to LAN port. Then user can control the system through Ethernet.
- Crossover UTP cable can be used for direct connection between PC and GeoBox. User needs to set PC TCP/IPv4 with the same domain segment as GeoBox (for instance, to set IP address at 192.168.0.105) and subnet mask at 255.255.255.0). Usually, normal UTP cable can be used.
- Open web browser (Google Chrome or Internet Explorer) and input GeoBox IP address (default is 192.168.0.100), user can see GeoBox WebGui and menu with virtual keys similar to OSD for further system operation. There is no additional software is required.

- If user can't connect the network, please power off/on GeoBox again to let PC detect G810 network settings.
- User can set DHCP for the connection. If necessary, please [Renew] DHCP to get IP address before network connection.
- GCT PC Tool is another web tool for system setting and operation. It can also update Firmware or MCU code. GCT can be downloaded from VNS website.
- Each GeoBox can set different IP address for independent operation and control from the same PC.
- After get into Network setting OSD, please use < > OSD keys to select OSD menu items and use ^ v OSD keys to change IP address.
- If GeoBox is connected with WiFi Router (through LAN port), user can control GeoBox through WiFi via PC, iPad or mobile phone.
- Default TCP server port is 1266.



Crossover UTP cable

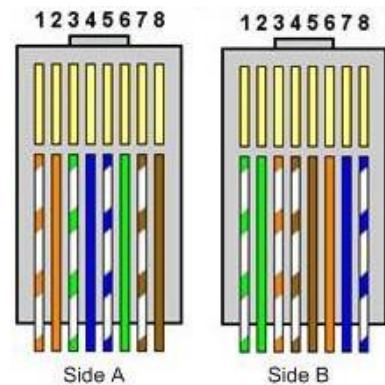

## 2.7. How to use IR Remote Controller

- IR remote controller has full functions for the operation of G814.
- IR receiver is on Front Panel. One 3.5ø mm audio connector for IR extender is located at Back Panel of G814. 1.8m IR extension cable is equipped in the packing. User can add audio cable to extend the distance up to more than 20 meters.
- IR remote control system is possible to be interfered and cause abnormal or discontinuous operation. Under this condition, Ethernet operation may be the best choice.



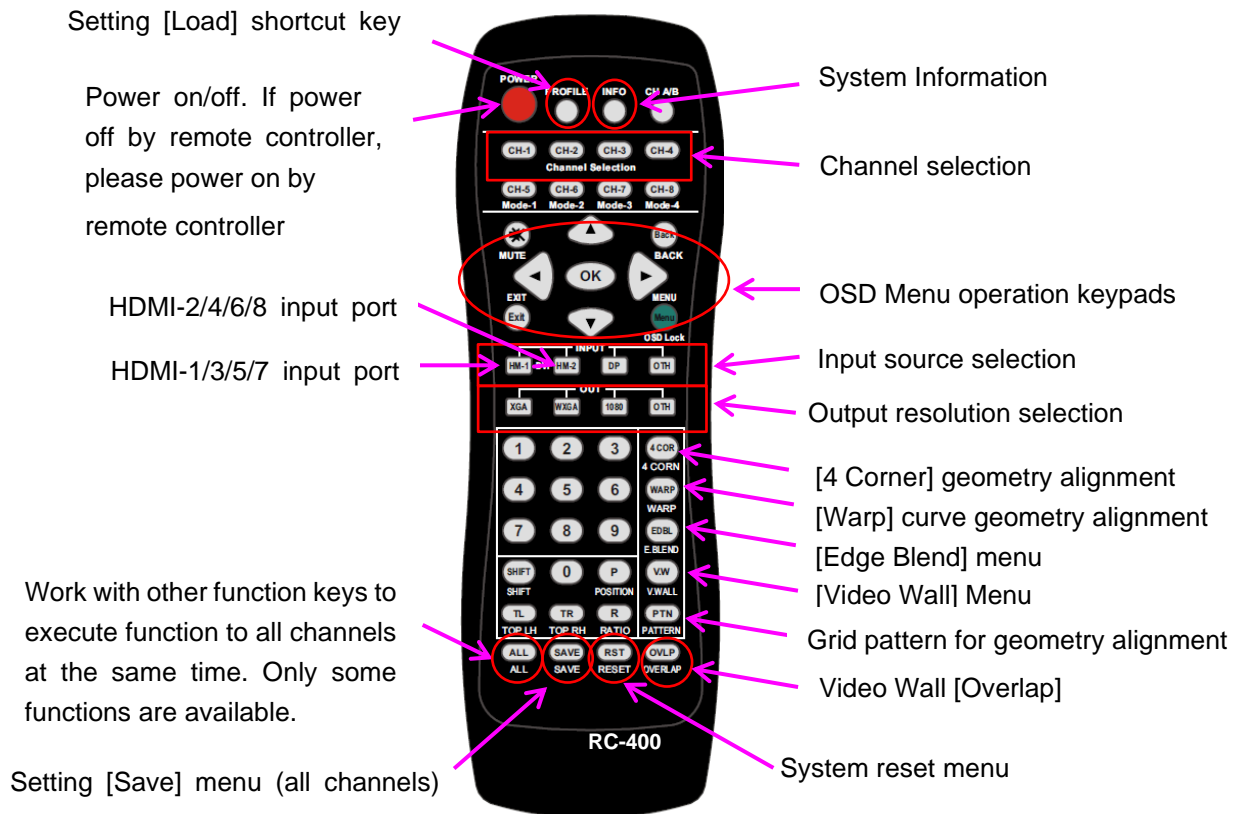

## 2.8. OSD Lock and unlock in multi-unit application

- In order to avoid interference among multiple GeoBox during the installation, user can set ID number for each GeoBox through [Options] Menu. Press number keys in Remote Controller to determine which GeoBox will be controlled.
  - 851: control GeoBox ID No. 1
  - 853: control GeoBox ID No. 3
  - 850: to unlock all units and user can control all GeoBox.
  - User will see flashing LED on front panel after press 85x number keys. It means the OSD menu in GeoBox with flash LED is locked and will not be controlled by remote controller.
- OSD Lock / Unlock: When continuously press [Menu] key in IR Remote Control for 5 seconds, the OSD function will be locked to prevent from setting change by negligence. To press [MENU] key for 5 seconds again, it will unlock OSD and user can manipulate the OSD again.

## 2.9. Full screen and native aspect ratio

- [Scaling] under [Image Properties] menu is to select the display mode either following signal source original aspect ratio or full screen display
- For edge blending application, please set to [Full Screen] mode. Otherwise, there may be abnormal display in some input timing.

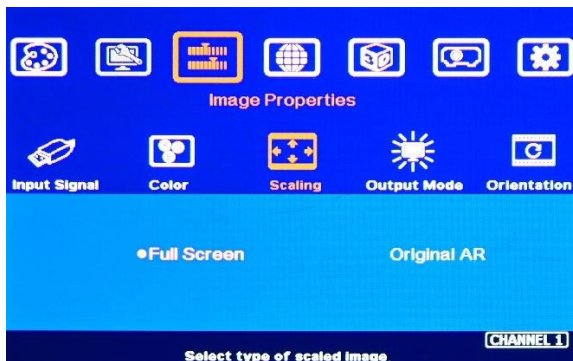

- [Full Screen]: to display full screen image no matter the input source is in what kind of aspect ratio.
- [Original AR]: the output display will keep the same display aspect ratio as signal source original aspect ratio. If the input is 4:3, then the output display will keep the same 4:3 aspect ratio.

## 2.10. Image rotation and flip

Image 90/270 degrees rotation only supports up to 4k/30Hz input signal. Image 0/180 degrees rotation and flip function can support up to 4k/2k @60Hz. When the image is rotated or flipped, the OSD will still keep at original direction without change. The direction for [Video Wall] settings will follow the image direction after rotated or flipped.

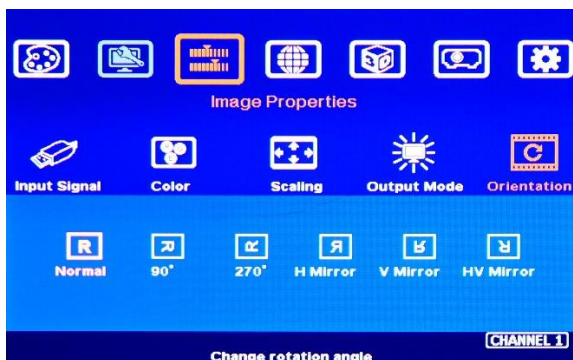

- Image 90/270 degrees rotation is for edge blending with projectors at portrait position to increase image height. There is no need to rotation signal source.
- Image flip is for projector to project image from rear or top position.
- After image rotation or flip, the OSD will still keep at the original direction.

## 2.11. System Power on sequence

If it is possible, please open GeoBox 30 seconds before power on signal source. It will make sure signal source can detect correct EDID. If user doesn't have source connection, it can be neglected.

## 2.12. Color adjustment

In edge blending application, color adjustment is important due to multiple units of projector images are combined together.

### 2.12.1. Global color adjustment: [Picture]

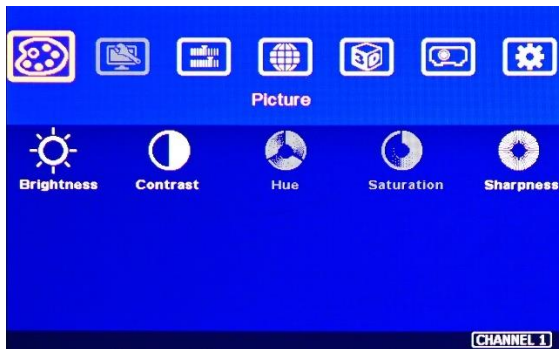

- [Picture] can execute below color adjustment for each processing channel.
- When input is 4:2:2 video:  
[Brightness], [Contrast], [Hue], [Saturation] & [Sharpness]
- When input is RGB 4:4:4:  
[Brightness], [Contrast] & [Sharpness]

### 2.12.2. Preset Color Temperature and independent RGB color adjustment

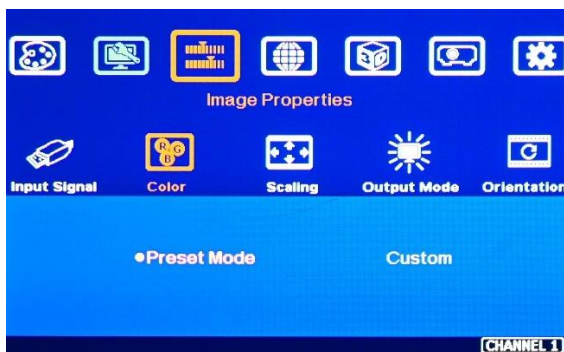

- [Color] under [Image Properties] menu can change preset color temperature and discrete [RGB] color in each channel.
- [Preset Mode]: [Neutral], [Reddish], [Bluish]
- [Custom]: discrete RGB color adjustment

### 2.12.3. Color adjustment function under [Edge Blend] menu

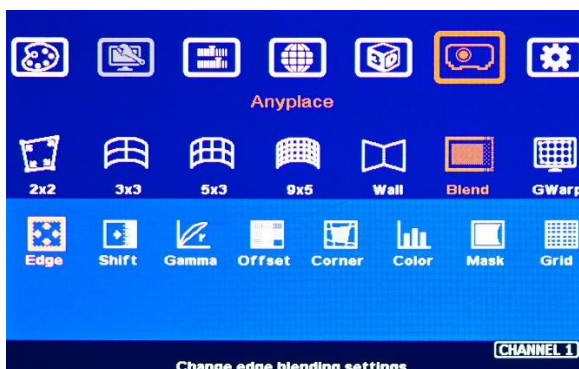

Below adjustment will apply to each channel separately.

- [Gamma]: for color compensation in overlap region
- [Offset]: for black level uplift in non-overlap region (limited adjustment range)
- [Color]: for color white balance correction (limited adjustment range)

## 2.13. System synchronization

When the system uses multiple projectors, the image should be synchronized together. GeoBox uses [Frame Sync] to synchronize all outputs based on the input signal vertical sync. When [Frame Sync] is applied, it is possible to lose sync during system setup and cause the projector to re-search the signal source. In order to provide smoother setup, GeoBox provides OSD for user to select different synchronization methods for easy setup.

- [Normal] (Frame Locked): We propose to set at [Normal] in most of the applications. When user reset system or adjust video wall settings, user will see projector re-searching the input source.
- [Fast]: time to sync the input source will be fast than [Normal]. During video wall settings, projector will reduce re-search behavior and will have smoother setup process.
- [Disable] (Free-Run mode): when GeoBox changes input source or timing, the output will still send out continuous output signal. The projector has lowest chance to re-search the input signal while system setup. It is recommended to set at [Disable] when execute setup in GeoBox.
- If multiple unit application is required, please set it at [Normal] to let all output channels have synchronized image without frame tear or synchronization issue.
- If the output refresh rate is not the same as input refresh rate. The frame lock function will be disabled and it may lose synchronization among output channels. If the input is 4k/30 with FHD/60 output, it will have no synchronization problem. If the input is 50Hz, please select 50 Hz output to avoid frame repeat and system synchronization issues.



## 2.14. System Reset

User can reset system through below method:

- Use small pin to insert RESET hole at back panel for 5 seconds, user will see [Reset to Default] message. It will apply to all channels at the same time. Profile Index data will be erased at the same time.
- Open OSD menu to reset the system. It will only be functional in one processing module (2 channels only).
- User [Reset] hotkey on remote controller will go to Reset OSD menu for one module only.
- When operating through OSD or remote controller, user can select to reset [Reset All], reset [Video Wall setting] or reset [Anyplace] (geometry) setting.
- When update FW and MCU, Profile Index data will be kept without change unless user executes RESET from reset hole on the back panel.
- **Reset from OSD or remote controller will not delete Profile Index data. RESET from RESET Hole on back panel will delete Profile Index data.**

## 2.15. System image aspect ratio adjustment

User can change the aspect ratio of the image with black borders or to stretch the image in specific direction to compensate the aspect ratio difference. The Maximum adjustment range is 1800 pixels in each edge. User can adjust [Overlap] value under [Video Wall] menu to change the cropping area and achieve aspect ratio change.



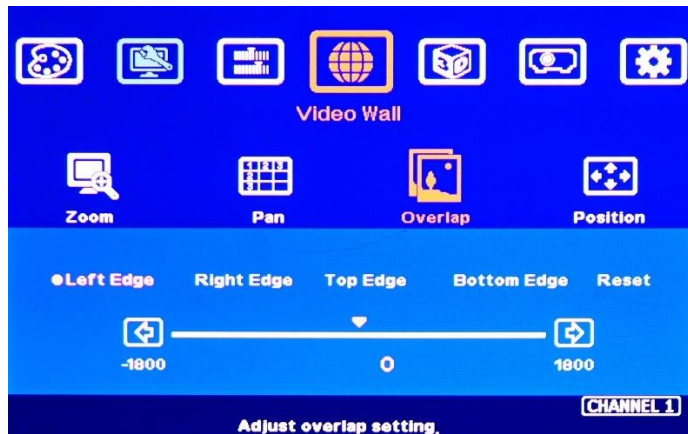

Activate [Overlap] under [Video Wall] menu

- User can select the channel and the edge required for edge shift, then adjust Overlap value to see aspect ratio change.
- The image position shift range is  $\pm 1800$  pixels in each edge.

- If the Video Wall [Zoom] is set to H=1 & V=1,  $\pm 1800$  pixels edge shift in RH and LH edges is only available under input signal up to 4k/2k @30Hz. Top Edge and Bottom edge are still functional when the input is 4k/60 with Zoom at H=1, V=1.
- If Video Wall [Zoom] is set to H=2 & V=2 or above, user can execute up to  $\pm 1800$  pixels overlap adjustment in all edges up to 4k/60 input resolution. The aspect ratio will change accordingly.
- In multiple projector application, when user adjusts Top or Bottom Overlap value in one projector, user needs to adjust the same Overlap value in other projectors to let all projectors has the same scaling factor.
- In two projector edge blending, when user adjusts horizontal aspect ratio, user needs to change Video wall Overlap value with the same number in both projectors until getting clear overlap image. In VNS Excel Spread Sheet calculation, if user calculates original Overlap value with 3840 input resolution, after increase 500 pixels in both outside edges in projector 1 (RH edge) and projector 2 (LH Edge), user can shrink the image width. However, the overlap region will become blurred. User needs to re-calculate Overlap value by new input resolution  $3840+500*2=4840$  to get correct video wall Overlap value. User can also continuously increase overlap value in both projectors to a point that both images can match together.
- The adjustment range of 1800 pixels is calculated according to the signal source resolution. If the signal source is 4k/2k and the adjustment value is 1200 pixels, when switching to 1080p input signal, the adjustment value will be converted to 600 pixels automatically to maintain the same image position. If the input signal source is 1080p and the adjustment value is 1000 pixels, when switching to 4k/2k input signal, the adjustment value should be 2000 pixels. However due to the maximum adjustment value is only 1800 pixels, the final image will follow 1800 pixels but not 2000 pixels for 4k input. It means the image aspect ratio will not the same as 1080p input source.

### 3. **Preparation for Edge Blending**

#### 3.1. **Determine source signal resolution**

- The image size and watching distance are two major factors to determine source signal resolution and number of the projectors.
- If the screen size is 20m and the watching distance is 5m, the signal pixel pitch should be around 5mm (around 1mm for 1 meter watching distance). The system resolution is about  $20\text{m}/5\text{mm}=4000$ . It means the system resolution should be around 4000 pixels in width and the vertical resolution should follow the projector native resolution. If 1080p projector is used, the ideal system vertical resolution is 1080.
- After determine the system resolution, please make sure all the equipment in the signal pipe line should be able to support this resolution or higher. It includes signal source output, edge blending processor and the total resolution of the projectors after edge blending.
- If user uses 8x XGA projector with 250 overlapped pixels, the total projector resolution after edge blending will be  $1024*8-250*7=6442$  pixels. It means it is enough to use XGA resolution projectors in this 20m screen case. If user uses FHD or WUXGA high end projectors with watching distance at 5m, the final video quality will be very similar as XGA projector under 4k signal source at 5m watching distance but will be better at less than 5m watching distance.
- We can provide free service to help customers to make project plan, including system configuration, type of projector, signal source and installation data.

#### 3.2. **Determine overlap region size and pixels**

- VNS provides an Excel Spread Sheet in the website for user to do edge blending plan.
- During Excel Spread Sheet calculation, user has some flexibility to determine the overlap region size by different projector resolution, lumens, image size and number of projectors.
- The most common overlap region is about 20% to 40% based on single projector native resolution. For 1024\*768 projector, the overlap range is  $1024*20\%-1024*40\%=205\sim409$  pixels. GeoBox test pattern default size is 32x32 pixels. Therefore, the final result will be around 7 grids (224 pixels) to 13 grids (416 pixels) for XGA projector and 12 grids (384 pixels) ~ 24 grids (768 pixels) for 1080p & WUXGA projectors. If the projector has accurate color and gamma curve, the overlapped pixel can be lower to 5 grids (160 pixels) in XGA projector. The actual pixel number should be determined based on the required screen size and the projector model used. Under the same screen width, if higher image is required, then the overlap region will be also increased.

- 
- User can simulate with different overlap pixels to get reasonable overlap region dimension between 50cm to 120cm. Reasonable overlap region will be easier for overlap color control. When executing simulation, the vertical image size can be over requirement and draw back to required image height through geometry alignment.
  - GeoBox maximum edge blend range is H=1920 pixels, V=1200 pixels. The black level compensation range is 900 pixels. If user requires black level uplift compensation and the overlap region is more than 900 pixels, please select the outside black level Block to execute black level uplift. The pixel number is based on native projection area without any adjustment from either projector or GeoBox. If necessary, user can adjust the overlap size through geometry alignment to decrease overlap size without changing projector location.
  - Please note that user can change the grid pattern size from 8 to 120 pixels but not only 32 pixels.

### 3.3. Relation between Overlap pixels and geometry alignment accuracy

- Proper selection of Overlap pixels will affect the control points in geometry alignment. If the Overlap pixel is 25% of the projector native resolution (or GeoBox output resolution), it will have less geometry alignment points due to control points in adjacent projectors will be at the same location. If the overlap pixel is not 25% of the projector native resolution, the control points will be at different positions. 37.5% overlap pixel will double the control points of the geometry alignment if compared with 25% overlap and have the best geometry alignment accuracy.
- [9x5 Curved] alignment will cut the horizontal image into 8 sections and the image in each section can be independently adjusted. In different output resolutions, there will be different pixel number in each section: XGA:  $1024/8=128$ , WXGA:  $1280/8=160$ , 1080p:  $1920/8=240$ .
- If the overlap area between two adjacent projectors has the same or multiple number as above, the geometry alignment control points in overlap region will be less. User can increase or decrease two or three grids (64 or 96 pixels) in overlap area to increase the control points in overlap region for more accurate alignment between adjacent projectors.
- Edge blending on flat screen, it will be easier for geometry alignment. User doesn't need to consider the relation between overlap pixels and geometry alignment accuracy.
- Below figure is an example for [9x5 Curved] alignment in 1024 resolution:

- **25% overlap region:**

*The adjusting points in projector A & B will be at the same position in overlap region*

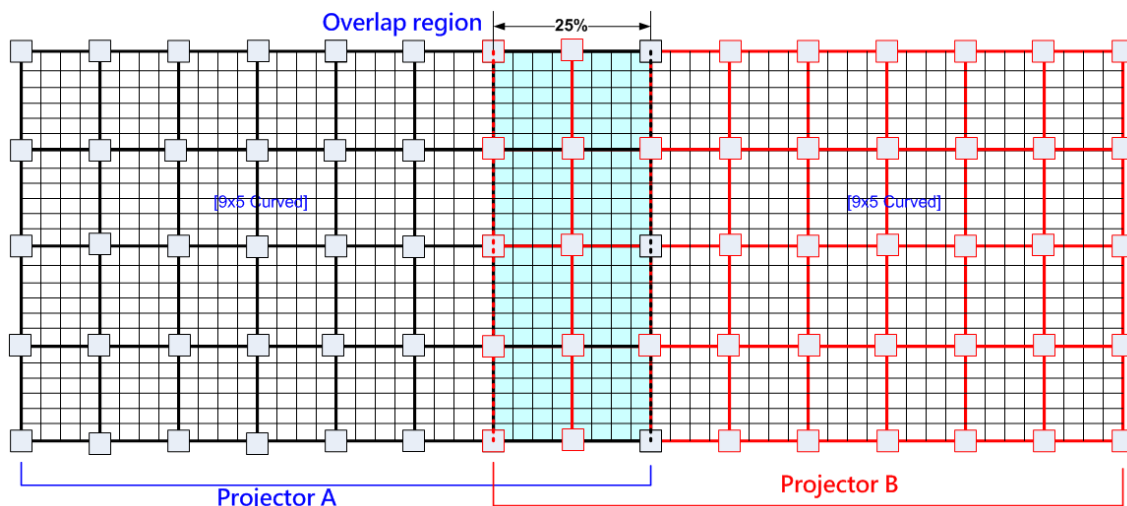

If the overlap is 256 pixels (25%) in XGA resolution, total adjusting points in overlap region are  $3 \times 5 = 15$ . The adjusting points in projector A & B will be at the same position in overlap region. User will have less adjustment flexibility. If increasing two grids (64 pixels) to 320 overlap pixels, user can have 30 adjusting points to get more accurate geometry alignment.

- **37.5% overlap region**

The adjusting points in projector A & B will be separated in 37.5% overlap region and increase geometry alignment accuracy.

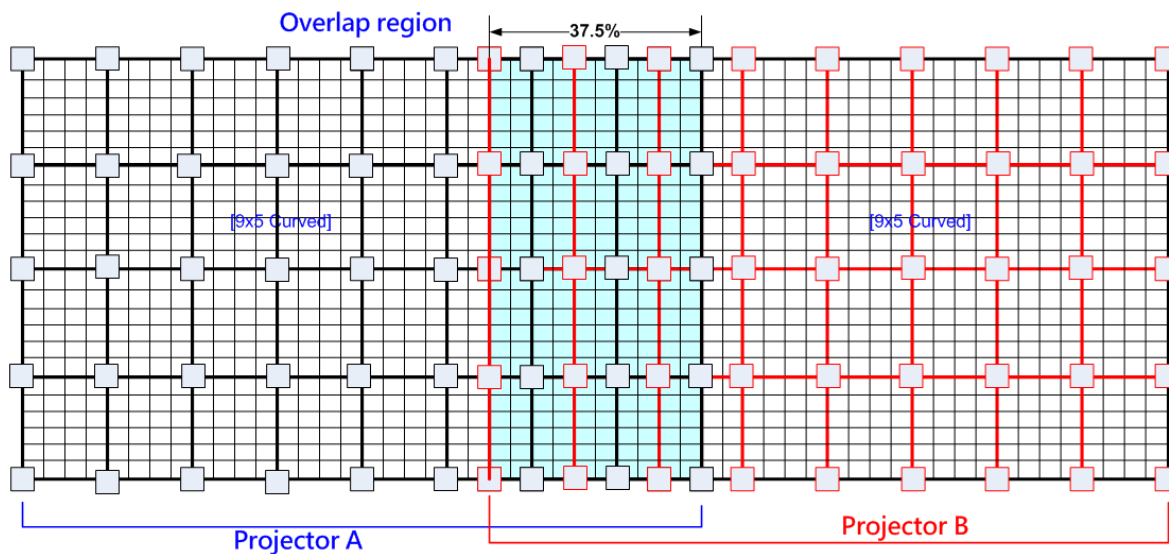

- **Recommended overlap pixels in different output resolutions**

Below is the list for the accuracy of geometry adjustment in different overlap pixels:

GeoBox output resolution	1920*1200	1280*800	1024*768
Min. adjusting flexibility	256/480/704	320/480/640	256/384/512
Max. adjusting flexibility	352/608/832	224/256/384/416/544/576	192/320/448/576

### 3.4. Get installation data from Excel Spread Sheet

- VNS can provide an Excel Spread Sheet for user to calculate necessary installation data for the project. It is important data for installation and setup.

**Project basic data**

Source resolution (H)	3840	Screen width	6.50 (m)
Source resolution (V)	800	Screen height	1.50 (m)
Projector resolu. (H)	1280	Projector lumen	3200 (Lum)
Projector resolu. (V)	800	Screen Aspect ratio	4.33 (required)

**Overlap pixels (32 pixels per grid)      Overlap %      Recommended**

Overlap pixel (H)	256	20.0%	20%~40%
Overlap pixel (V)	0	0.0%	25%~40%

Recommended overlap region: Min. 50 cm width

Qty of projector (H)	3	Throw ratio (Min)	1.20
Qty of projector (V)	1	Throw ratio (Max)	1.70

**Final output resolution**

Horizontal resolution	3328
Vertical resolution	768
Extended pixel (H)	98
Extended pixel (V)	0

**Video wall setting value**

Position of projector (H)	1	2	3	4	5	6	7	8	9	10
LH edge overlap value	0	98	197	x	x	x	x	x	x	x
RH edge overlap value	197	98	0	x	x	x	x	x	x	x

Position of projector (V)	1	2	3	4	5	6	7	8	9	10
Top edge overlap value	0	x	x	x	x	x	x	x	x	x
BTM edge overlap value	0	x	x	x	x	x	x	x	x	x

**Final result checking list (PJT: Projector)**

Final Image size (meter)		Final Illuminance Lux (Lum/m2)		Image size for each PJT	
Width	6.50	PJT lumen	3200	Width (m)	2.500
Height	1.56	Final Illumin	819	Height (m)	1.563

Overlap region size		Original aspect ratio		Projector throw distance	
Horiz. (m)	0.500	Projector	1.60	Min (m)	Max (m)
Vertic. (m)	0.000	Final result	4.16	3.00	4.25

\* Final mage height should be equal or larger than screen. User can shrink image to have the same image height as screen by GeoBox geometry adjustment.

\* Standard luminance is 400-800 Lux for restaurant and big conference room, 1000-1500 Lux for trade show. 3D: 500 Lux (single projector)

- Below are assumptions for the above 3x projectors edge blending system Excel calculation.
  - ✓ Screen Size: 6.5m\*1.5m with watching distance within 2m (pixel pitch less than 2mm)
  - ✓ Input signal resolution: 3840\*800 (Pixel pitch is 6500mm/3840=1.7mm = 1.7m watching distance, optimized vertical resolution is the same as projector native resolution: 800)
  - ✓ Number of projectors: 3 projectors
  - ✓ Projector resolution and lumens. 1280\*800 (native resolution), 3200 Lum
  - ✓ Overlap pixels and dimension. 8 grids=8\*32= 256 pixels (50cm)
  - ✓ Projector throw ratio: 1.2-1.7 (based on projector spec)
- How to operate VNS Excel Spread Sheet
  - ✓ Input all the data in Yellow column, including Source Resolution, Projector Resolution (GeoBox output resolution), Screen size, Projector throw ratio, Projector Lumens, No. of projector and Overlap Pixels. User can try different configurations and select the most cost effective one with the image height a little higher than required.
  - ✓ User will get below data from the Spread Sheet.
    - Final image size for each projector is 250cm\*1.56cm with Overlap region of 50cm in width.
    - The image height should be higher than the required one. User can shrink the vertical height to required dimensions through geometry alignment. The vertical adjustment range in each edge is 600 pixels.
    - Optimized content resolution: 3328\*800 (This is the ideal resolution to set EDID). It is suggested to select the same vertical resolution (800) as projector native resolution to get the best result.

- 
- Installation distance: 3m-4.25m.
  - It is calculated from throw ratio and image wide for each projector. (2.5m\*1.2=3m, 2.5m\*1.7=4.25m)
  - The final luminance is 819 Lux. It will be enough for inside room environment.
  - The overlap value in Video Wall setting:
    - When user sets Video Wall Zoom, it will split the image equally for each projector. The projectors will be installed with some Overlap Pixels for edge blending. Therefore, Overlap Value is to crop more pixels for each section based on the Overlap size between two adjacent projectors.
    - LH Projector: select RH edge: +197 (to crop more 197 pixels for LH projector. These 197 pixels are based on source resolution.
    - Projector (Center): LH edge=+98, RH edge=+99 (total 197)
    - RH Projector: LH edge: +197
    - If the input source resolution while video wall setting is different from the calculation, the result will be wrong.
    - After finish setting, user can check the image, if some overlap area is blurred, user can increase or decrease Overlap Value with 1-2 pixels and select optimized one.
  - ✓ It is allowed to have different overlap pixel among projectors. "Irregular" Spread Sheet is required to calculate the data.
  - ✓ Please contact dealer or factory to get necessary assistance for the Spread Sheet.

### **3.5. Apply Spread Sheet data for projector installation and GeoBox setting**

#### **3.5.1. Installation data from Spread Sheet from previous section:**

- Image size for each projector: 250cm \*156cm
- Overlap region: 50cm
- Installation distance based on throw ratio 1.1-1.7: between 300cm-425cm
- Installation height: install the projector at a position with minimum keystone at both vertical edges.

#### **3.5.2. Mark projection region for each projector**

- Based on the calculation data, user can easily determine the image location for each projector.
- Using laser Level tool and mark the locations for each projector with paper tape, including 4 borders and center line of the screen. The paper tape shall not damage the surface of the screen.

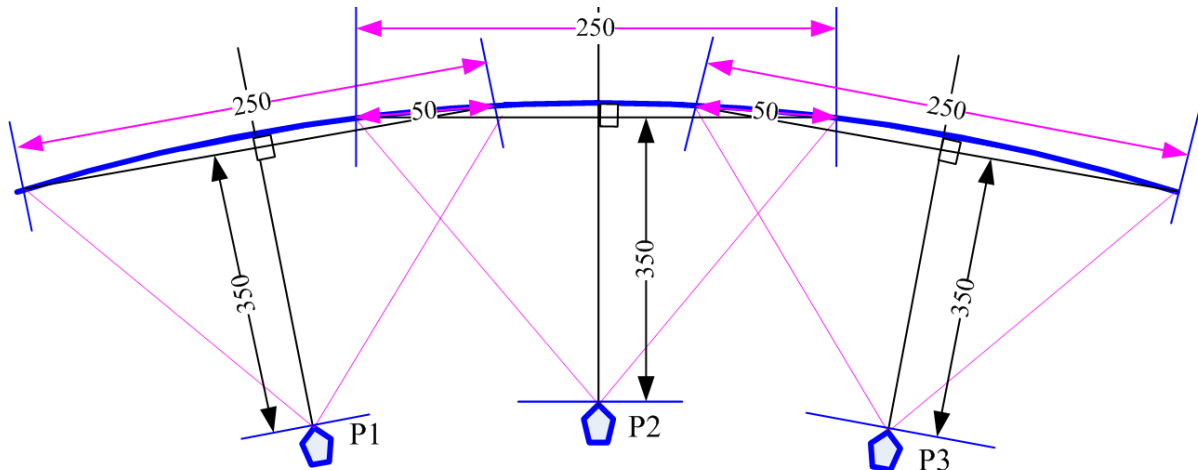

### 3.5.3. Installation the projector

- To install the projector at a location as showed above with the image just a little over required region at any point. Too large image will lose image resolution and brightness.
- Minimum keystone effect will optimize the image quality with less geometry alignment.
- The image height from the projector can be higher than required and user can draw down the image height through geometry alignment. The adjusting range is up to 1200 pixels in the top and bottom edges.



During the installation, Laser Level is a good tool to get correct horizontal and vertical line and make sure each projector can cover correct display

### 3.6. Projector settings before edge blending

- Please reset all projectors to factory default settings.
- Set to ceiling mount if necessary.
- Disable below items:  
Auto keystone, auto aspect ratio, auto color compensation, auto source.
- Select a display mode with gamma 2.2 or standard display mode. After edge blending, if user still sees some banding in overlap region, please select the best one from different display modes.
- If there is color deviation among projectors, please try to correct color difference through projector color adjusting function to let all color as close as possible.
- Enable [multiple projector display] mode if the projector has this setting.

### 3.7. **GeoBox settings before edge blending**

- Use small pin to insert into RESET hole on the back panel of GeoBox for 5 seconds to reset GeoBox to default setting. This [Reset] will apply to all channels at the same time.
- Select channel number, then select input port and output resolution in each channel separately.
- Set output resolution to be the same as projector native display resolution. Each channel shall set output resolution separately.
- When set 1080p output for WUXGA projector, the display image will be lower.
- Connect with a signal source to HDMI-1, then connect loop out port to HDMI-3 via HDMI cable.
- The signal source for installation should be no less than 1080p.
- Check input/output LED indicators and make sure to have correct system connection.
- **User can set [Frame Sync] at [Disable] to eliminate [Source Re-search] in projector during setup. After finish the setup, please set to [Normal] to get synchronization in all outputs.**

## 4. **Geometry alignment**

### 4.1. **Select the right Grid Pattern for geometry alignment**

Grid pattern is required for geometry alignment. User can activate test pattern through [Pattern] hotkey in remote controller or through WebGui and GCT PC tool.

- The default grid size is 32\*32 pixels. User can select different grid size from 8-120 pixels. Each channel can be set separately. In edge blending, the grid size in all channels shall be the same.
- The OSD show-up time can be determined by [Options]→ [Accessibility]→ [Menu Time Out]. If set at "0", the OSD will show up all the time unless input timing is changed or OSD [Exit].
- If user finds different grid size in different projectors, please check the grid pattern size, output timing setting and the aspect ratio settings in each projector. GeoBox needs to set at [Full Screen] display mode under [Image Properties]→ [Scaling] menu.
- If user executes Geometry alignment, the pattern will appear automatically after select the adjusting point and press Enter.
- There are 6 pattern styles for user to select. When user presses [Pattern] key, it will circulate from [White]→ [Red]→ [Green]→ [Yellow]→ [Cyan]→ [White grid + background]→ [OSD menu + Background]
- If user wants to apply his own test pattern, please select the last transparent pattern mode to show up background user pattern.
- User can select different pattern color for each projector while doing edge blending setup.

- Note: some projector RGB pixels are not at the same location. It will cause position deviation. Please recheck with White grid pattern for final result.
- User can see geometry adjusting value when select [Background + OSD] display style.
- **PS. User can select the last pattern mode [OSD Value + background] and apply external test pattern for geometry alignment.**

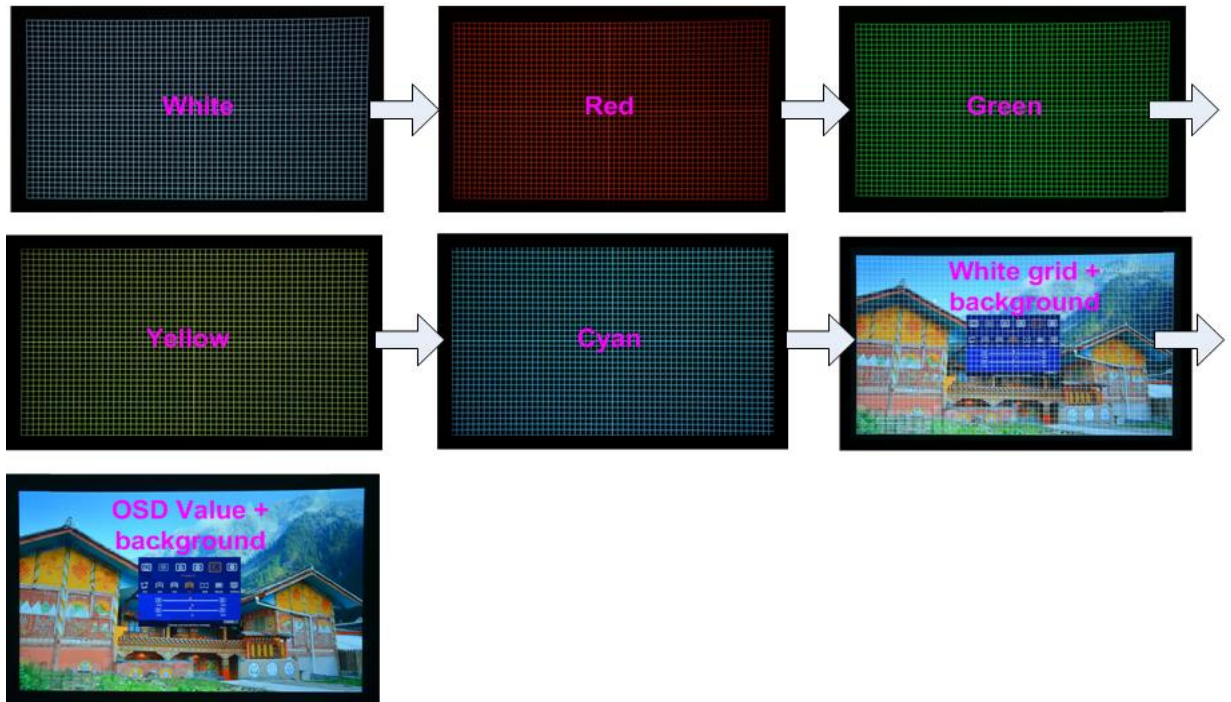

## 4.2. Grid pattern pixel size selection

- The pixel size in grid pattern for geometry alignment is selectable to meet high end simulation system geometry alignment requirements. The grid size in both horizontal and vertical directions is from 8 to 100 pixels with 1-pixel increasement. H&V grid size will be the same. User can select grid size under [Edge Blend] menu.
- Default grid size for both H&V directions are 32x32.
- In order to get optimized result in video wall [Overlap] value, user can use VNS Excel Spread Sheet and apply an overlap pixel in the Spread Sheet to get a near integrate number in Video Wall [Overlap] value, then select the grid size to match this overlap pixel.
- In low resolution projector with low overlap grid number, user can select a grid size to maximized the overlap region to improve edge blending quality. For example, when the overlap pixel is only 186 pixels, if user selects 32x32 pixels as grid size, then user needs to reduce the grid size to only 160 pixels (5 grids) to let the grids from adjacent projector to stack together. If user selects a grid size of 31x31, then user can keep 186 pixels (6 grids) as overlap pixels.

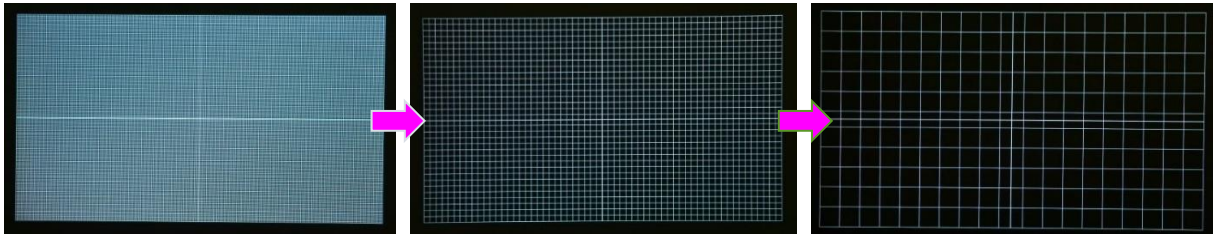

Below is the OSD menu for the selection of grid size.



### 4.3. Geometry alignment

Geometry alignment is to align the image position to let the projection image match the screen and also let image grids between two adjacent projectors be combined together. This step will take most of the time for edge blending. User can execute geometry alignment through remote controller, GCT PC tool or WebGui through Ethernet connection.



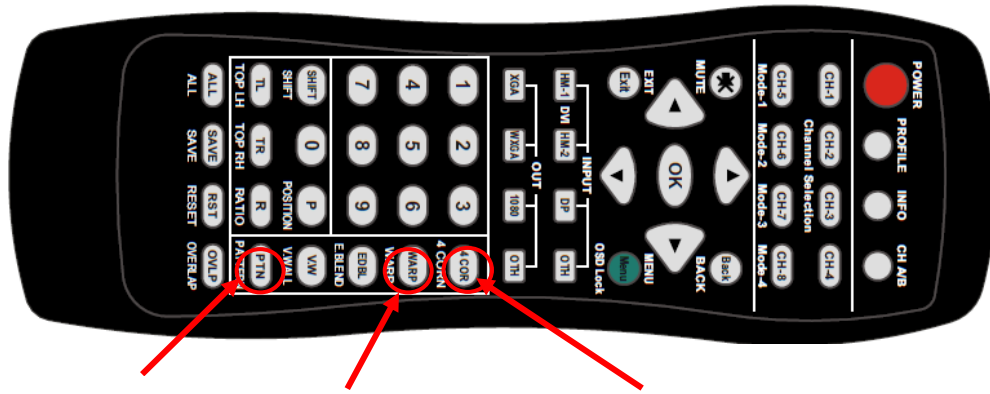

Test pattern hotkey      [3x3], [5x3], [9x5] Warp hotkey      [2x2] 4 Corner adjustment hotkey

#### 4.3.1. Geometry alignment through remote controller

- Please be familiar with OSD operation from remote controller, including activating grid pattern, channel switching and hot keys for [4 Corner], [Warp], [Video Wall], [Edge Blend], [Pattern] and [INFO].
- [OSD Time Out] is default to "0". It will ensure the OSD and grid pattern will not be turned off automatically. Input timing change will disable OSD and exit from grid pattern.
- User can install IR extender receiver near screen for easy GeoBox operation (Please add audio extending cable to extend the distance up to 20 meters). If multiple units of GeoBox are used and IR receivers are put together, please set [Box ID] for each GeoBox so that user can control each GeoBox separately through [85x] command. Please see more details in section 10.3.1.
- Each channel should execute geometry, video wall setting and edge blending setting separately.

#### 4.3.2. Activate Grid Pattern

- Use channel selection keys and [Pattern] hotkey to show grid patterns in all projectors. Press [Pattern] key again will change grid color. To set two different pattern colors in adjacent projectors will be more convenient during geometry alignment.
- If user finds the grid size between adjacent projectors is different. Some possibilities:
  - The projection image sizes between two projectors are different (Zoom setting or projection distance is different).
  - Output resolution settings are not the same.
  - Projector aspect ratio setting is different.
  - GeoBox is set at [Original AR]. It shall be [Full Screen].
  - Set different grid pattern size in each channel.
- If user doesn't use VNS Excel Spread Sheet to calculate the image size in each projector, please try to set the same projection height prior to geometry adjustment. In this case, the image width and overlap grid size for all projectors will be similar and is easy for geometry alignment.

### 4.3.3. [2x2] 4 corner geometry alignment

- In most of applications, no need to do keystone correction in the projector before geometry alignment.
- If using short throw ratio projector in curved screen display, the image will have big distortion. Please use projector to do geometry alignment first before GeoBox.
- [2x2] alignment will adjust whole image with the same scaling factor. [Warp] alignment will adjust only some portions of the image.
- Please follow the sequence [2x2]→ [3x3]→ [5x3]→ [9x5]→ [17x9] to do geometry alignment to ensure entire image will have uniform scaling factor.
- Apply [2X2] Corner geometry alignment and draw the corners to pre-marked locations.
- If no pre-marked location, please use [2x2] alignment to let the image in each projector with the same horizontal position and also let the vertical lines without keystone effect.
- Measure the image size in each projector, to reduce the size of the larger image and let adjacent projectors have similar grid size and grid number in overlap area.
- Adjust top or bottom edge to let adjacent patterns aligned together, then align another edge.
- If the screen is curved, it is possible to have some image inside or outside the screen after 2x2 adjustment. However, it doesn't matter once the image covers entire screen before 4 corner adjustment. [Warp] alignment can adjust the image position back to required position.

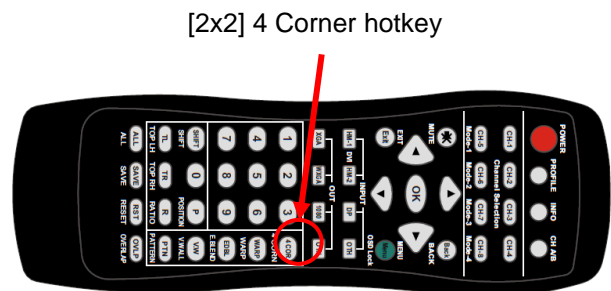

### 4.3.4. [3x3], [5x3], [9x5], [17x9] Warp alignment

- After finish [2x2] corner alignment, apply [3x3 Curved] geometry alignment to let 9 adjusting points be located at the required position including 4 corners, edge center points and center line position.
- Please use [5X3], [9x5] & [17x9] for further geometry alignment and let all the grids in overlap area with good grid stacking from two projectors.
- For curved screen, if there will be some difference in the grid size in adjacent projectors, user can use Linearity Grid Line adjustment (in next section) to adjust the grid size and finish the image position fine tune within shorter time.

- After finish Warp alignment, user can use [2x2] for complete image position fine tune without changing the Warp result. If user executes [3x3] alignment again after [9x5] alignment, [9x5] grid position will be reset and only keep [3x3] grid point information.
- In ideal condition, all grids in edge blending area between two adjacent projectors shall be aligned together. In some special case, the vertical lines in edge blending area have some gap and can't match 100%. Please try to align the grids near center of overlap region with good stacking. It allows small image shift in both sides of the overlap region because edge blending will reduce the effect of the mis-alignment in side borders. User can also adjust [Overlap] value in video wall settings to compensate this deviation and keep reasonable image quality.
- After the above processes, if the grid pattern in edge blending area still can't stack together, user can reduce one or two overlap grids from adjacent projectors to separate the adjusting points in each projector and get more accurate geometry alignment result. If the result is still not good, please apply 120x68 grid point adjustment. The adjusting result in remote controller can be further adjusted through GCT PC tool directly.
- Geometry alignment range from remote controller can be up to 600 pixels in [2x2] + 600 pixels more in [3x3] for one corner/edge.
- If over GeoBox geometry adjustment range, the image will be broken. Please adjust projector installation position or use projector geometry alignment function to cover some adjustment.
- Ultra-short throw ratio projector is not suitable for curved screen display due to big image distortion. Once user can execute geometry alignment to required position, the image quality will be reduced, especially in the Text mode. Longer throw ratio will get better result.
- After geometry alignment, all the grid patterns in overlap region should be stacked together.

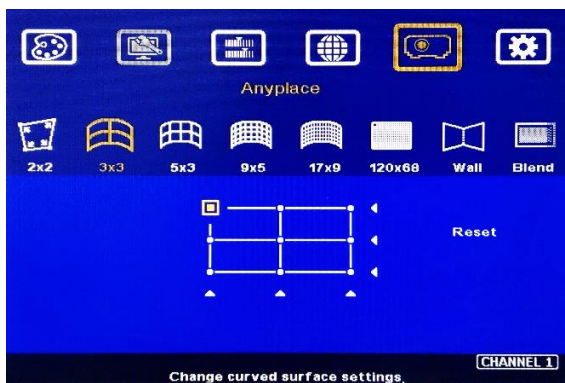

[3x3] warp hotkey

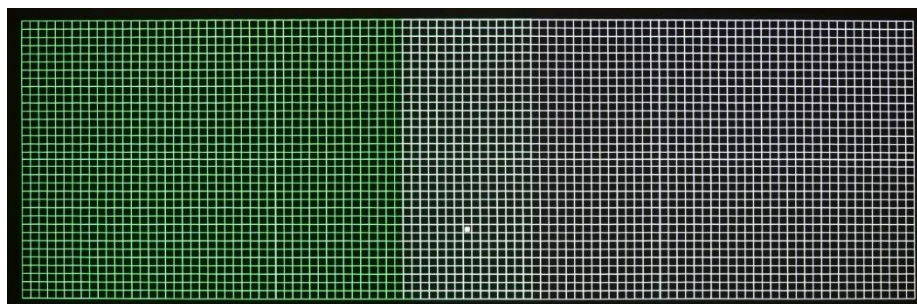
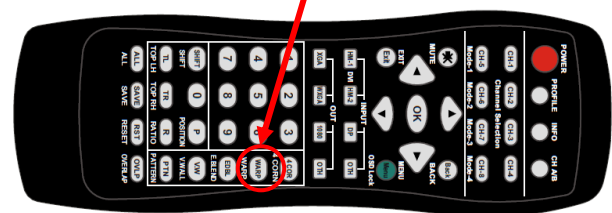

### 4.3.5. Linearity grid line adjustment

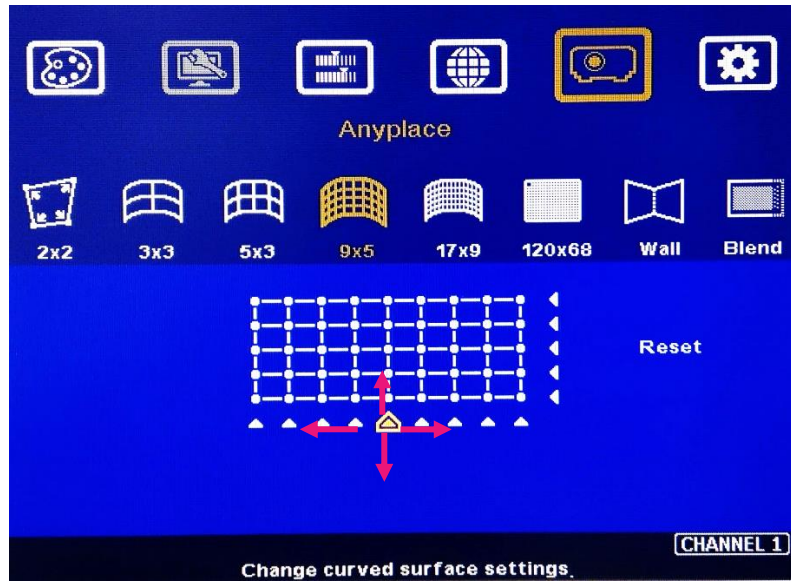

The control point can shift grid lines in both horizontal and vertical directions.

- Linearity grid line adjustment is under [3x3], [5x3], [9x5] & [17x9] warp alignment menu. User can select the control point, then press ENTER to do grid line adjustment. Each control point can shift the image in both horizontal and vertical directions.
- When user projects the image to curved screen, the image grid size will continuously change—the grid size at the center will be bigger than both sides. Ultra-short throw projector will be more serious. Linearity grid line adjustment is designed to correct this kind of grid line gap difference.
- This function can co-work with Warp and Edge Blending function.

Original projector image on curved screen  
(The grids size at center will be bigger)

After apply Grid Line Adjustment

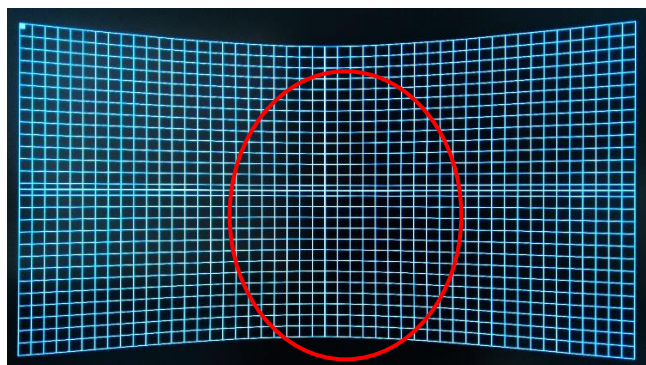
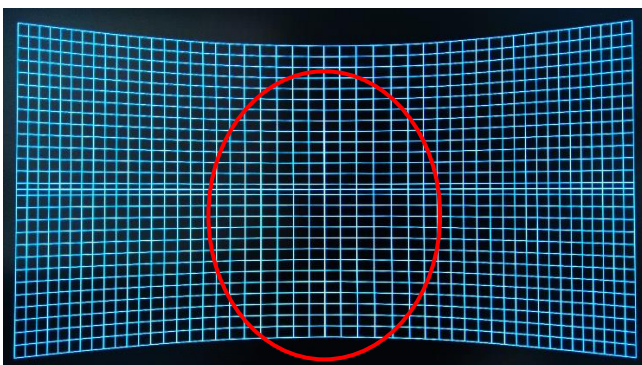

#### 4.3.6. “W” shape Corner Wall geometry alignment

**Important note:** When apply Corner Wall function, all the other geomtry alignment function will be disabled. User can only execute geometry alignment through 10 points of Corner Wall adjustment. 4 corner control points can execute 4 corner alignment same as [2x2] geometry alingment function. Edge Blend function will be still available.

Corner Wall alignment allows user to adjust the image at 90 degree corner wall or images at two sides of the pillar at wall corner through 10 control points across the edge of the image. It can execute horizontal and vertical corner wall alignment. User can only select either horizontal or vertical alignment at one time. This function can co-exist with edge blending function but not warp function. The image position can be adjusted as below:

- 4 corner positions of the image. The whole image position will be shifted the with same scaling factor. The adjustment range is 1200 pixels in both H&V directions.
- The rest 6 control points can correct the image position at wall corner or the images at two sides of the pillar at corner wall. It can shift the image positions in horizontal and vertical direction with the control range up to +\_1200 pixels.
- User can't use ultra-short throw ratio projector for corner wall application. Otherwise, the image distortion will be too big to be adjusted and may also create focus issue. The ideal projector throw ratio should be larger than 0.8:1.

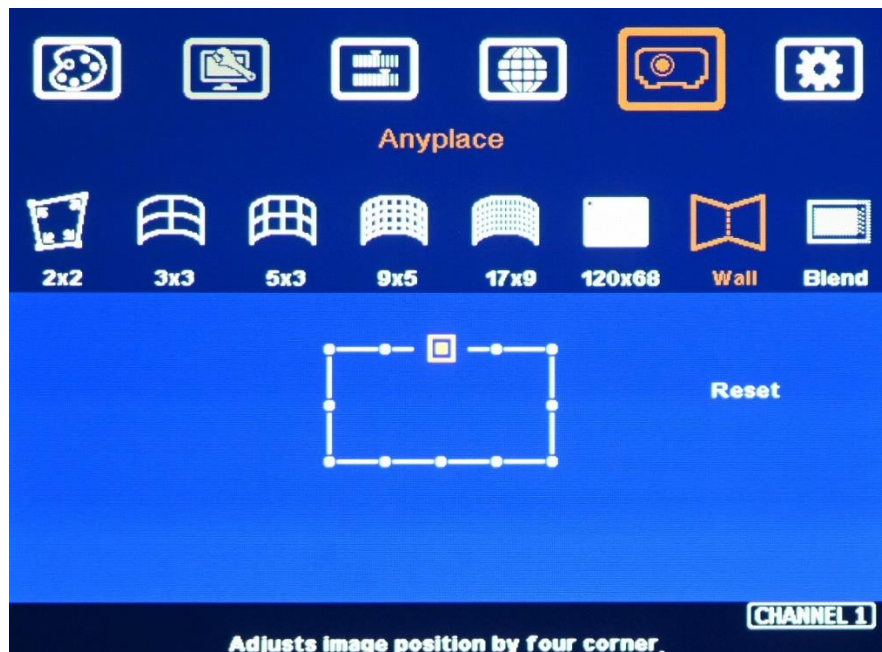

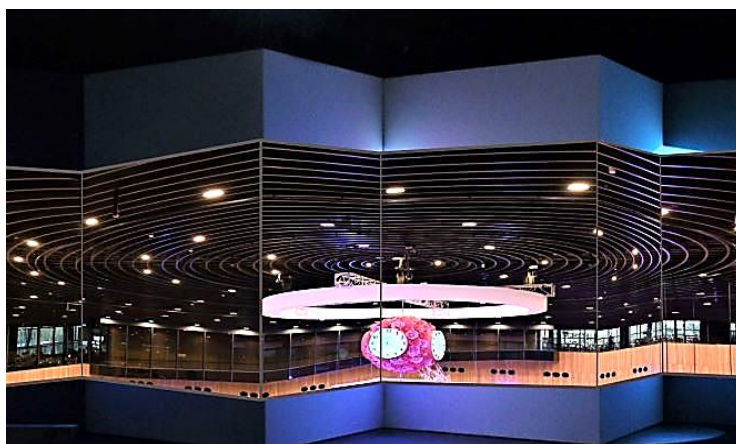
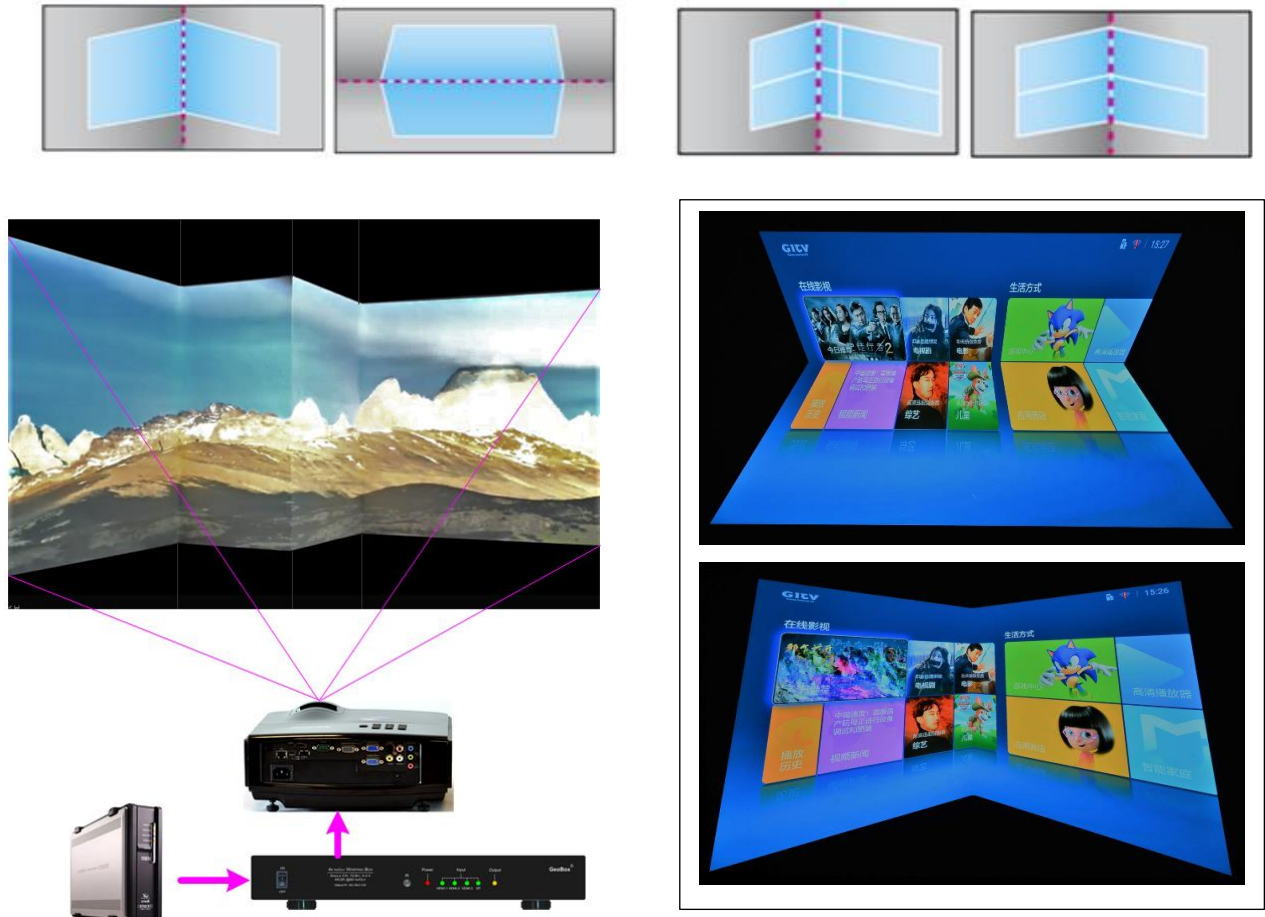

**Corner wall application on curved screen**

If user wants to implement Corner Wall function on curved screen, user can connect the signal to another G116 or G110 to do warp alignment, then connect the output to another unit for further Corner Wall alignment. Then user can execute curve alignment and Corner Wall adjustment at the same time. Please note that if another warp processor is connected, the system latency will increase to 4 frames.

#### 4.3.7. Important notice on curved screen display

- The video quality in edge blending on curved wall corner is not easy to control due to different projection angles.
- We recommend to apply curve radius larger than 3.0 meters and use a projector with throw ratio larger than 0.8:1. Ultra-short throw ratio projector can't be used.
- If the radius is less than 3.0 meters, we propose to change the design with rectangular wall. Then user can apply [Corner Wall] alignment or project the image on separate wall from each projector.
- When implement [Corner Wall] adjustment, the warp function will be disable and only 4 corner alignment is available.
- If shorter throw ratio projector is used, to select a projector with warp function will get more flexible geometry alignment range.
- User can use projector warp or keystone correction function to do preliminary alignment before GeoBox alignment to enlarge the flexibility in geometry alignment range.

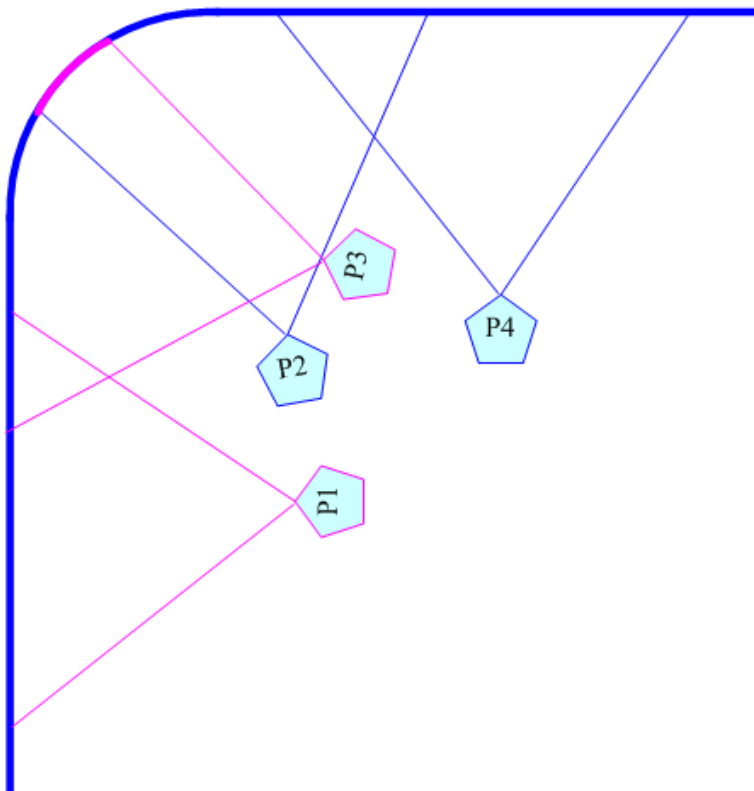

#### 4.4. Geometry alignment via GCT PC Tool

- GCT is a PC tool executed through PC. No software driver is required. Once user opens GCT and connects with PC through Ethernet or USB, user can execute edge blending settings through PC keyboard and mouse up to [17x9] control points and [120x68] pixel position fine-tune. After finish the setup, user can save the result to Box and no more PC is required.
- User can backup system settings in PC and copy to other units.
- Firmware and MCU code update can be executed through GCT. User can control multiple units at the same time through different IP address.
- Please see download “GCT PC Tool Quick User Guide” from website to get more details.

#### Procedures for geometry alignment through GCT PC Tool:

- (1) Click [Warp Adjust] to access below geometry alignment Menu.

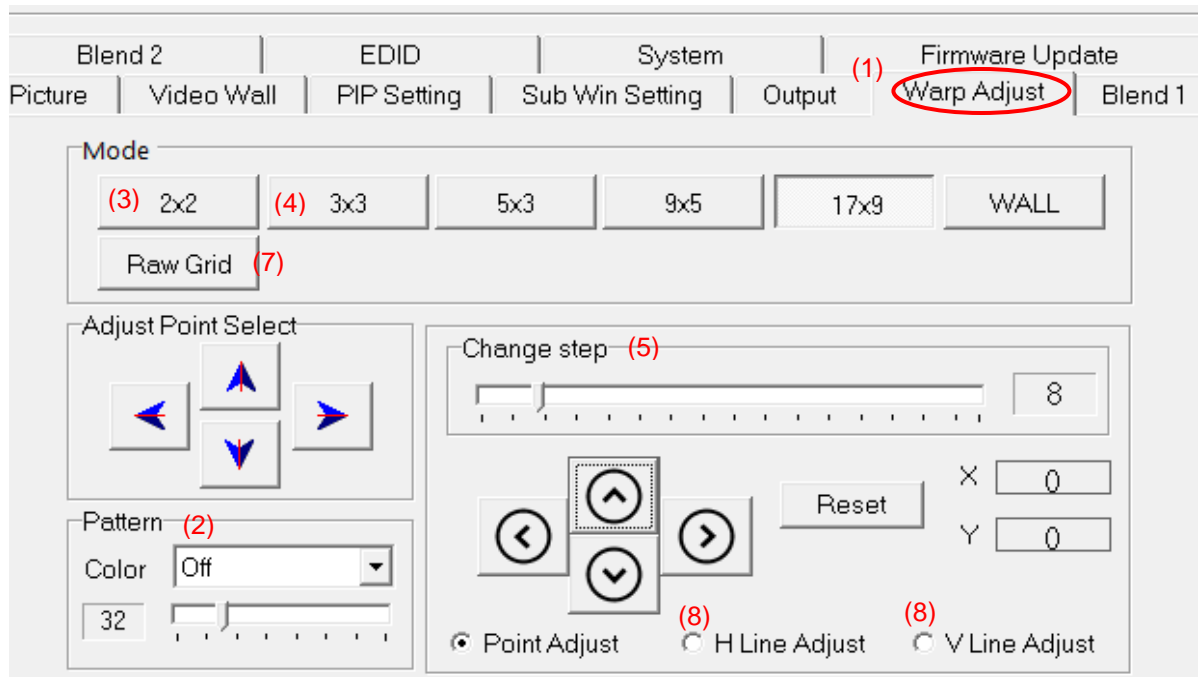

- (2) Select Pattern color for each channel. Adjacent channel should have different colors.
- (3) Start from [2x2] geometry alignment in all channels and let the image in each projector to be located at desired (pre-marked) location.
- (4) Following [3x3]→ [5x3]→ [9x5]→ [17x9] in all channels at the same time to let all grid lines in overlap area to be stacked perfectly.
- (5) The adjusting step can be selected. User can also use keyboard hotkeys to select:  
[CTRL+Arrow]: 8 pixels/step. [SHIFT+Arrow]: 1 pixel/step

- 
- (6) If finish [17x9] alignment, user can return to [2x2] for further alignment but if return to [5x3], only [below [5x3] warp data will be kept.
  - (7) [Raw Grid] is for detailed position fine-tune after [17x9]. The maximum adjustment point is 100. After [Raw Grid] alignment, user can go back to [17x9] or [2x2] to do further adjustment. The adjustment points under [Raw Grid] adjustment will remain at the same location without changing by [2x2] or other alignment.
  - (8) When projecting to curved screen with short throw ratio projector, the image will have bigger grid size at the center and smaller at both sides. User can use Linearity Grid Line adjustment (8) to do the whole line movement. It will reduce the time for the adjustment. This function is available under [3x3] to [17x9] and in both horizontal and vertical lines.
  - (9) After finishing warp adjustment, we propose to save to Profile Index as back up.

### **Keyboard hotkeys for geometry alignment**

Please set PC language in English so that user can use Keyboard hotkeys to execute system operation.

- [CTRL+ALT+#]: select channel
- [M]: Change circularly Warp Adjust mode from [2x2] → [3x3] → [5x3] → [9x5] → [17x9] → [Wall] → [2x2] → [3x3]...
- [CTRL + Arrow]: Select control point
- [Arrow]: adjust control point position, default is 8 pixels/step.
- [Shift + Arrow]: Geometry adjustment with 1 pixel/step
- [P]: Enable grid pattern with different color
- [CTRL + P]: turn OFF pattern to see OSD menu for the operation by remote controller
- [R]: Reset geometry alignment settings in current mode and channel.
- [U]: undo the last geometry alignment step.

### **Save settings**

- ✓ After finishing all channel geometry alignment, click [System] to save all channel settings into [Profile Save].
- ✓ Click [Save Setting] to save data into PC as backup or copy to another Box.

### **Geometry alignment data editing**

- ✓ User can Load Profile to recall warp data and do further editing.
- ✓ Geometry alignment result can be edited through both GCT or IR controller.

## 5. [Video Wall] setting

- The purpose for Video Wall Setting is to split the image and assign specific image to each projector. The overlap pixel setting is to change the cropping area for each projector based on the overlap size. Overlap value shall be accurately adjusted to avoid blurred image in overlap region. All of these functions are under [Video Wall] menu.
- Each channel shall execute [Video Wall] settings separately.

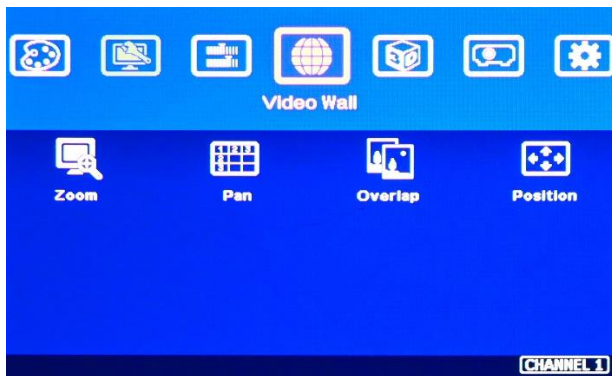

- Press Menu Keypad on Front Panel to enter [Video Wall] OSD menu.
- [Video Wall] hotkey on the bottom right position of the remote controller is available for quick access.
- Video wall function can crop image for edge blending and assign to projectors.

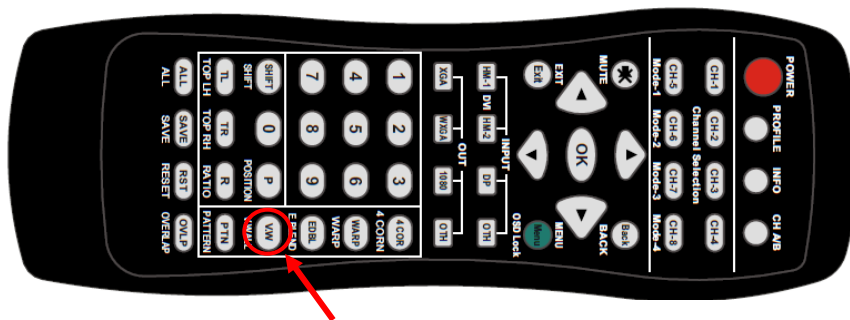

[Video Wall] menu hotkey

### 5.1. [Zoom]: split the signal source

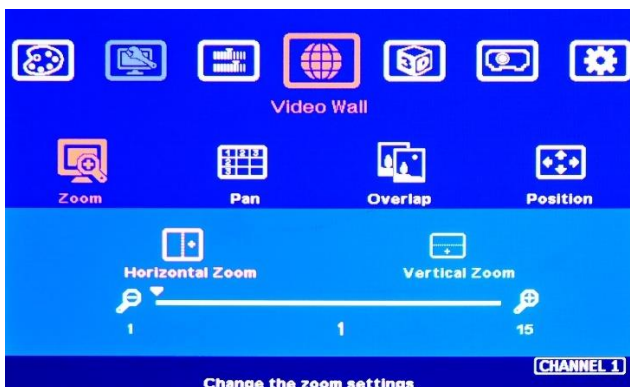

- Use [Zoom] to split input image in horizontal and vertical directions. Maximum split images are 15x15 in both horizontal and vertical directions from single input source.



*For 3 projectors at horizontal position, Horizontal Zoom=3, Vertical zoom=1*

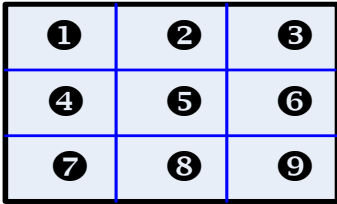

*For 3x3 displays (9 projectors), Horizontal Zoom=3, Vertical Zoom=3*

**5.2. [Pan]: assign image location**

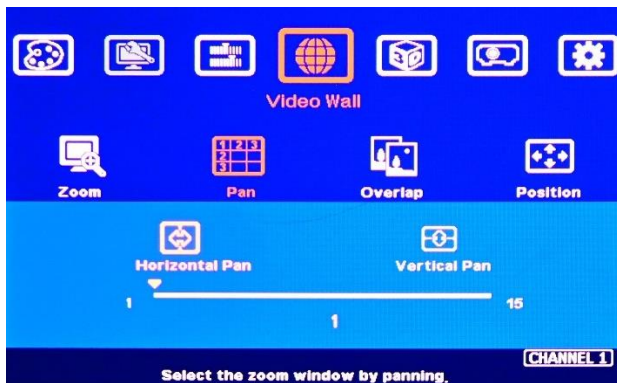

- Use [Pan] to determine the location of each split image in both horizontal and vertical directions.
- Default setting:  
Horizontal Pan=1  
Vertical Pan=1

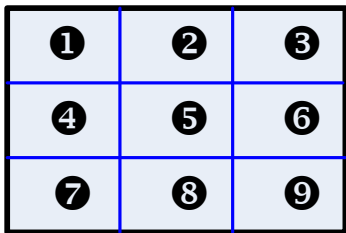

*For No. 3 projector:  
Horizontal Pan = 3  
Vertical Pan = 1*

*For No. 6 projector:  
Horizontal Pan = 3  
Vertical Pan = 2*

**5.3. [Overlap]: crop the right image for each projector**

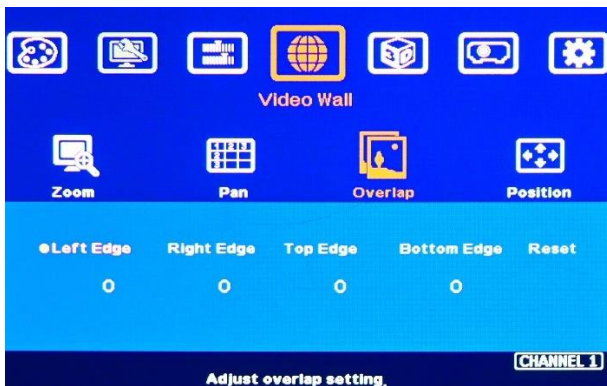

- Use [Overlap] to adjust overlapped pixels between two adjacent projectors
- It can also change image aspect ratio.
- Max. Overlap range is +\_1800 Pixels

➤ In multiple projector applications, the Overlap value can be determined by VNS Excel Spread Sheet as showed in below chart with RED mark. User can follow this value to get the right overlap settings with clear image.

- This Overlap value will be calculated based on several factors—such as input resolution, projector resolution, quantity and overlap region size.
- If the overlap regions have different size due to installation position limitation, please use Irregular Excel Spread Sheet to calculate overlap value.
- User can use Video Wall overlap setting to fine-tune the image position in overlap region. It can compensate geometry mis-alignment and let image become much clearer.

**Project basic data**

Source resolution (H)	3840	Screen width	6.50 (m)
Source resolution (V)	800	Screen height	1.50 (m)
Projector resolu. (H)	1280	Projector lumen	3200 (Lum)
Projector resolu. (V)	800	Screen Aspect ratio	4.33 (required)
Overlap pixels (32 pixels per grid)		Overlap %	Recommended
Overlap pixel (H)	256	20.0%	20%~40%
Overlap pixel (V)	0	0.0%	25%~40%

Recommended overlap region: Min. 50 cm width

Qty of projector (H)	3	Throw ratio (Min)	1.20
Qty of projector (V)	1	Throw ratio (Max)	1.70

**Final output resolution**

Horizontal resolution	3328
Vertical resolution	768
Extended pixel (H)	98
Extended pixel (V)	0

**Video wall setting value**

Position of projector (H)	1	2	3	4	5	6	7	8	9	10
LH edge overlap value	0	98	197	x	x	x	x	x	x	x
RH edge overlap value	197	98	0	x	x	x	x	x	x	x
Position of projector (V)	1	2	3	4	5	6	7	8	9	10
Top edge overlap value	0	x	x	x	x	x	x	x	x	x
BTM edge overlap value	0	x	x	x	x	x	x	x	x	x

**Final result checking list (PJT: Projector)**

Final Image size (meter)		Final Illuminance Lux (Lum/m2)		Image size for each PJT	
Width	6.50	PJT lumen	3200	Width (m)	2.500
Height	1.56	Final Illumin	819	Height (m)	1.563
Overlap region size		Original aspect ratio		Projector throw distance	
Horiz. (m)	0.500	Projector	1.60	Min (m)	Max (m)
Vertic. (m)	0.000	Final result	4.16	3.00	4.25

- \* Final mage height should be equal or larger than screen. User can shrink image to have the same image height as screen by GeoBox geometry adjustment.
- \* Standard luminance is 400-800 Lux for restaurant and big conference room, 1000-1500 Lux for trade show. 3D: 500 Lux (single projector)

- If no Excel spread sheet is available, user can apply video wall test pattern and execute overlap adjustment. Once the pattern can match together, it is done with the right overlap value.

**5.4. [Position]: shift image position without changing image size**

After cropping, user can shift image position at H&V directions without changing image size. Usually, it is for video wall application to fine tune image position. In projector edge blending application, user only changes Overlap value in one edge but not execute image shift.

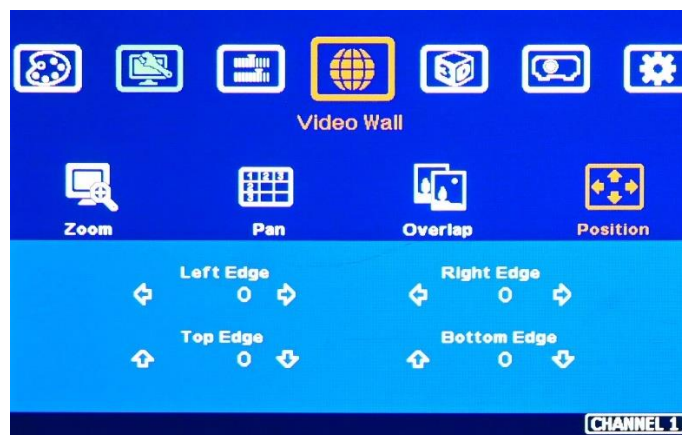

## 6. [Edge Blend] settings

- Edge Blend is to merge the images from multiple projectors to become one seamless image.
- The scaling factor between two adjacent images shall be the same. It means the image size under the same resolution should be the same.
- Geometry alignment is required before edge blending:
  - ✓ To let the image has the same grid size (same scaling factor in both horizontal and vertical directions)
  - ✓ To let images overlapped together in horizontal lines and vertical lines.
- Sub-menu under [Edge Blend] menu
  - ✓ [Edge]: select the right edge and set overlap pixels. The pixel no. is same as the overlap grid size multiple grid number. If overlap is 10 grids, the overlap pixel is 320 in default grid size.
  - ✓ [Shift]: to shift image edge blending location and implement [Edge Mask] function for non-overlapped edges with black background.
  - ✓ [Gamma]: adjust gamma value in [Transition] and [Gain] in each channel to improve banding effect in overlap region.
  - ✓ [Offset]: to do black level uplift in non-overlapped area to compensate light leakage in projectors.
  - ✓ [Corner]: to do precise [Offset] location alignment.
  - ✓ [Color]: to do White Balance correction for individual projector.
  - ✓ [Mask]: Mask out unnecessary image in the image edge.
  - ✓ [Grid]: set grid pattern size for Horizontal and Vertical directions.

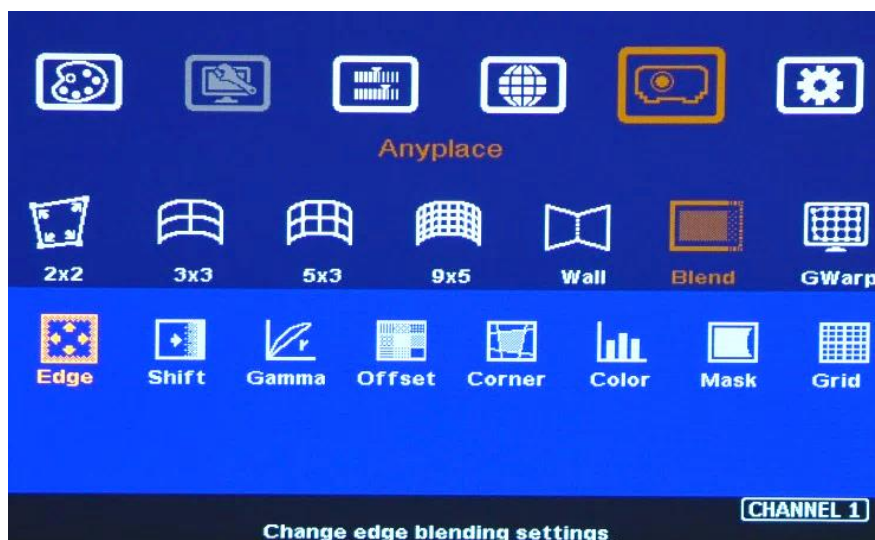

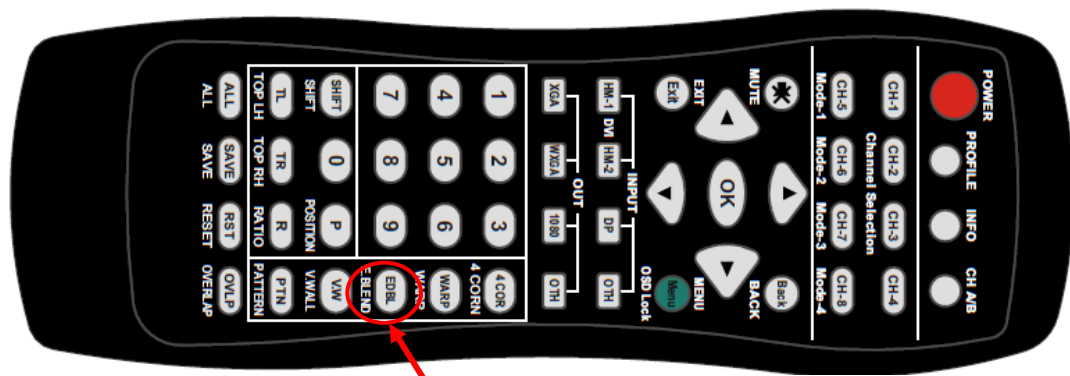

[Edge Blend] hotkey

## 6.1. [Edge]: select location and set edge blending value

- [Edge] is to select the edge for edge blend and set overlapped pixel number.
- User can execute edge blending at any edge.
- Maximum edge blend pixels are H=1920, V=1200.
- Color indicating lines will appear when set edge blending pixels.
- User needs to adjust the color indicating lines to match together (green to green, red to red). The final overlap value is the same as actual overlap number (grid size \* grid number).

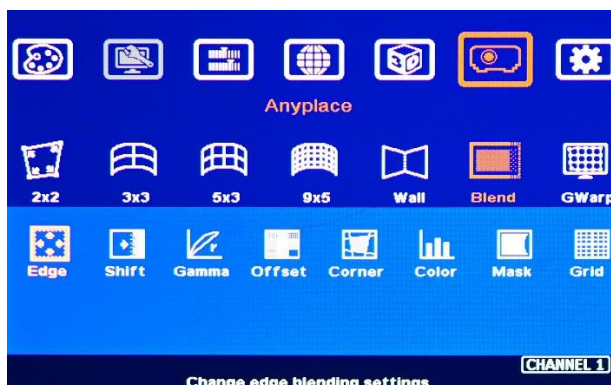

For 3 projector edge blending as example:

- To select [Right Edge] for LH projector
- To select both [Right Edge] & [Left Edge] for center projector.
- To select [Left Edge] for RH projector

## 6.2. [Shift]: shift edge blending position and execute Edge Mask

- [Shift] has two functions: one is to shift [Edge Blend] location and another function is to do [Edge Mask] in not [Edge Blend] borders.
- When user selects the edge in Edge Blending area, user can apply "+" value (0 to +500) to shift the whole [Edge Blend] position. If the value is "-" (0 to -10), user can see color uplift in the edge of the Edge Blending area. The purpose is for user to do color fine tune in edge blending area.
- When user selects the edge without [Edge Blend], [Shift] will change image border location with black background without changing image size and location. It implements [Edge Mask] up to 500 pixels following the final result after geometry alignment.



- [Shift] is to shift [Edge Blend] location in [Edge Blend] edge. If the value is set to “-“, it will uplift the color in the border of edge blending area.
- It will execute [Edge Mask] on the edges in non-overlapped region.

### 6.3. [Gamma]: Color correction in edge blending area

- Different projectors may have different gamma curves. Different “Display mode” in the same projector will also have different gamma curves. Edge blending default gamma curve is 2.2. These gamma curves will affect the color in edge blending area. The common issue is gray color banding effect. These issues are more significant in pure color or white back ground display.
- [Gamma] function is to adjust the gamma curve in edge blending area for each projector through independent RGB gamma curve adjustment.
- The major reason for banding effect in edge blending area is related to projector color setting and gamma curve. All projectors shall have the same gamma setting and [Display Mode].
  - ✓ User needs to select right display mode (gamma curve 2.2 is the best gamma value in the projector setting) and fine tune the color difference among the projectors before edge blending to minimize the possible banding effect in edge blending region.
  - ✓ Some projectors have [Multiple unit application] menu for user to choose while executing edge blending function.
  - ✓ Please disable [Dynamic] color function in the projectors. These functions may change gamma curve based on the content and affect final edge blending image quality.



**Three sub-menus under [Gamma] menu:**

- [Transition] Gamma:
  - ✓ To set edge blending area gamma value via discrete RGB gamma curve value adjustment. The gamma value range for each RGB color is from 0.9-3.0.
  - ✓ When overlap region is brighter, user can decrease the gamma value and if overlap area is too dark, user can increase the gamma value to improve video quality.
  - ✓ User can apply pure color RGB and adjust R.G.B. value separately to see the difference.
  - ✓ Transition gamma adjustment may not solve color banding issue once the projectors gamma curves are not the same, smooth or have variation among projectors.
- [Gain] gamma:
  - ✓ This function can change the gamma curve in each projector separately.
  - ✓ It can further improve edge blending result, especially while two adjacent projectors have different gamma curve.
  - ✓ User can start with one projector in one color first and see the color change in overlap area. Then adjust other colors to match required color.
  - ✓ Usually, when user adjusts Gain Gamma in the first projector, it will affect the color in one side of the overlap region. User can adjust another projector to compensate another side. The adjusting value for adjacent projector can be different.
- [Offset] gamma:
  - ✓ [Offset] gamma will change RGB gamma at the same time. It will apply to each projector separately.
  - ✓ This function is only available when user implements [Offset] function for black level uplift. After user implements [Offset] setting for black level uplift, user can adjust [Offset] gamma to change the gamma curve for black level uplift.
  - ✓ User can use this function to fine-tune the brightness level between overlap region and non-overlap region in edge blending application.

**Below picture shows banding effect in edge blending area**

This issue is related to many factors:

- ✓ Screen: gain value under 1.0 is recommended
- ✓ Projector: shall be the same model with the same gamma and Display Mode settings.
- ✓ Usually, Laser projector can get good result due to accurate gamma and color.
- ✓ Signal content: to avoid pure color or pure white color content. Multimedia is the best.
- ✓ Overlap range: too small overlap range will cause banding effect. 20%-40% with more than 60 cm width is recommended.

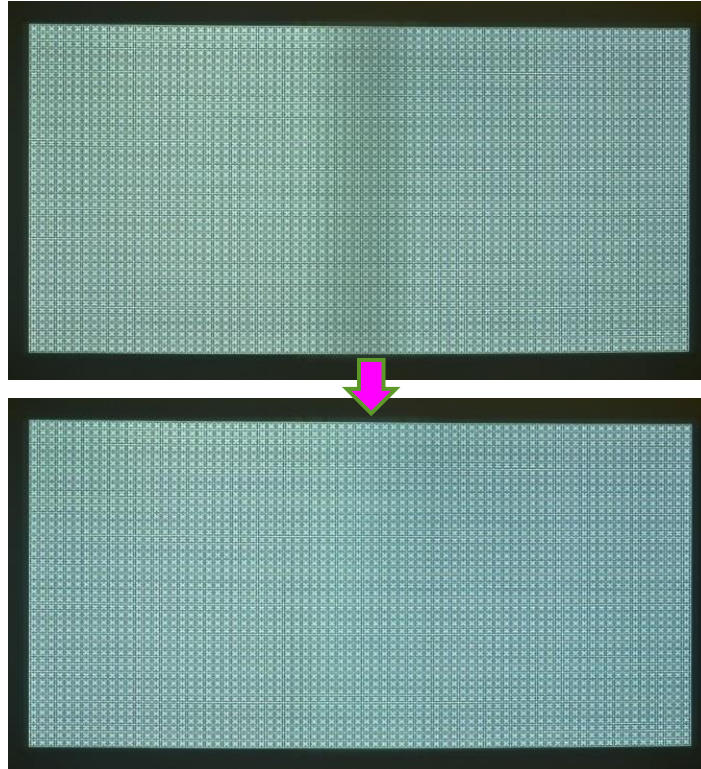

#### 6.4. **Black level uplift: [Offset] & [Corner] adjustment**

- If the ambient light is dark, audience will see grey region in Edge Blending area. It is due to light leakage from projector optical system and can't be fixed by signal processing. Low contrast ratio projector will be more serious. The only solution is to apply [Offset] function to uplift the color in non-transition area to compensate the visual color difference.
- Projector with higher native (not dynamic) contrast ratio will have less light leakage. Usually, DLP projector will have higher contrast ratio with better result. Laser projector has high contrast ratio with accurate color and gamma setting and is suitable for edge blending.
- [Corner] function is to do accurate position alignment.

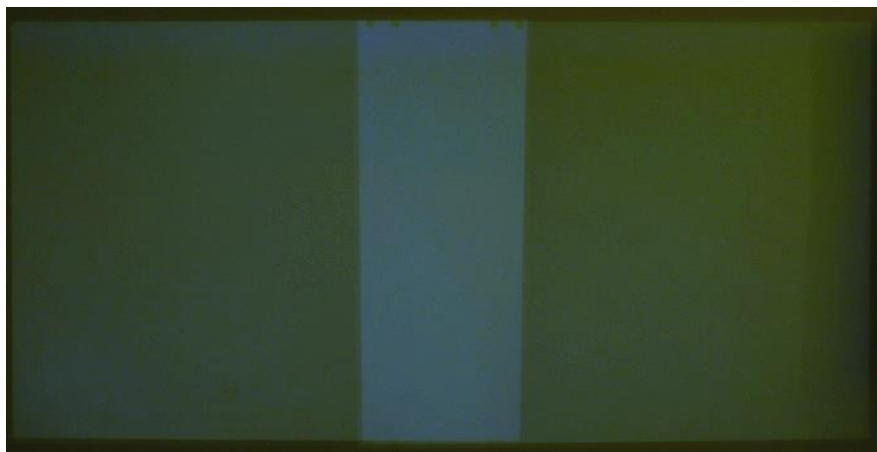

### 6.4.1. [Offset]

- [Offset] is to set the level for color uplift. It should be determined based on the brightness level in overlap region.

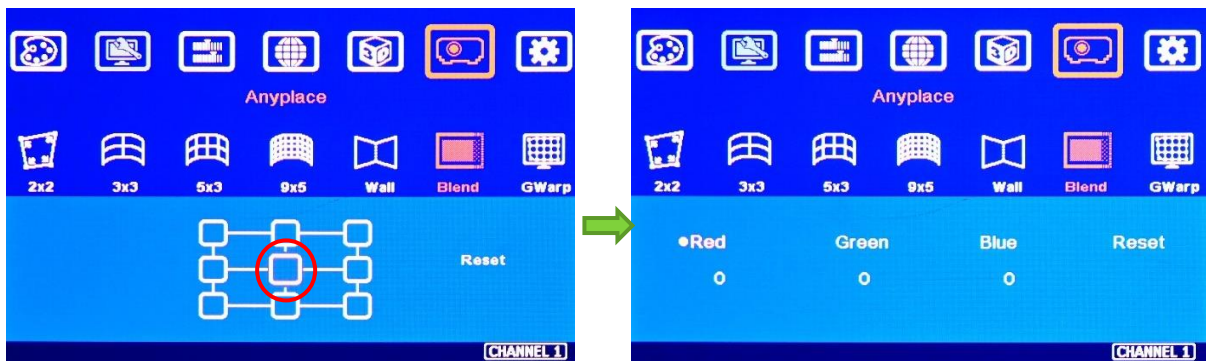

- User can select the region for black level uplift and apply the offset value in R.G.B. color to compensate the color difference between overlap region and non-overlap region.
- If user executes more complicated edge blending such as 4 projectors at 2x2 location. The maximum areas for black level uplift may increase up to 9 locations.
- RGB color adjustment range is from 0-255. For DLP projector, the adjusting value is near 60-90. For LCD projector, the adjusting value is near 80-120. RGB is independent.

### 6.4.2. [Corner]

- Adjust the correct location for black level uplift by [Corner] menu.
- When user adjust the location of the control points, user will see the change of color uplift position. This region starts from original projection area before geometry alignment. It is not the same as overlap area.
- The maximum adjustment range is +\_900 pixels in vertical direction and +\_1200 pixels in horizontal direction.

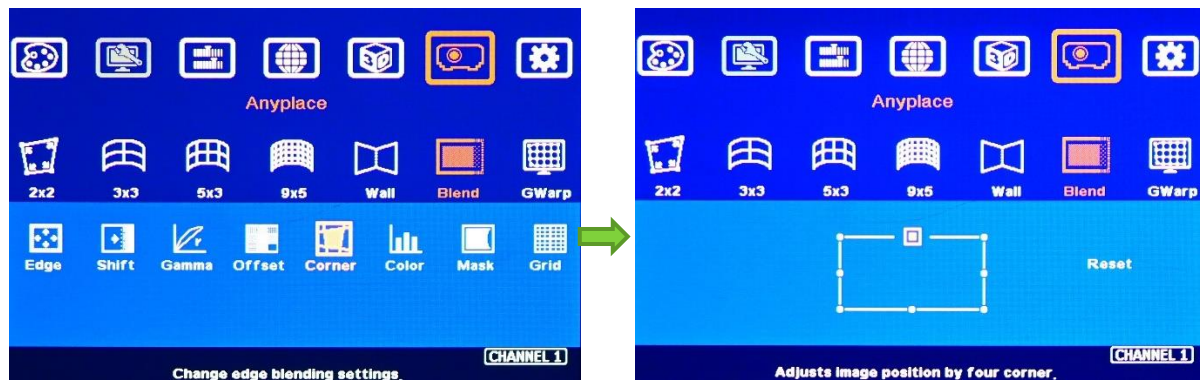

- Projector display imager, such as DMD, LCD and LCOS, will have some image borders due to active display window is not at full range of the imager. In dark environment, viewer may see a little light leakage in image borders. It is outside active display area and can't be fixed.
- If user finds some position deviation between Black Level uplift border and projector Light Leakage border during [Corner] adjustment, it is caused by poor geometry alignment between two adjacent projectors. Please make sure to have good image grid alignment in that area.
- Below is to show color adjustment in black level uplift areas through above method. It can show different colors with different shape of the borders. Maximum adjusting area is nine.

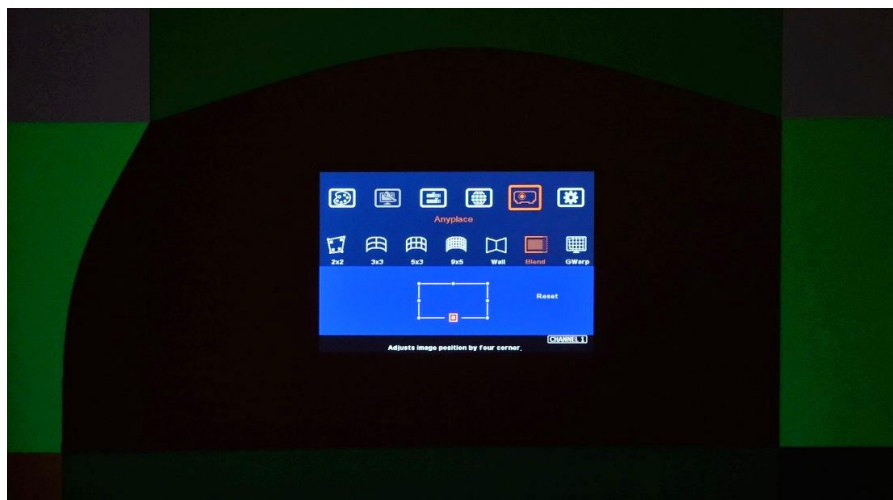

### 6.4.3. Procedures for black level uplift

#### Two projector horizontal edge blending as example.

- Turn off ambient light and apply a black background content on the screen. If no black background content, user can disconnect input signal to get black image.
- Projector may have dynamic color adjustment function. In ideal case, please apply the actual display content and select the location that will show clear light leakage image. It can make sure to get the best result.

- Procedures for black level uplift:
  - ✓ Select CH-1 (LH projector), select center block as showed in red circle.
  - ✓ Press [OK] and adjust RED color to 150. User will see red color enhancement.
  - ✓ [Back] to [Corner] menu.
  - ✓ Start from [Right Edge] (top, middle, bottom) and adjust uplift location to match light leakage.
  - ✓ [Back] to [Offset]→ Select center block→ RED→ adjust the value to 70
  - ✓ Fine-tune R.G.B color to let LH projector have similar color in overlap and non-overlap area.
  - ✓ Fine-tune the uplift location again by [Corner]. If necessary, please fine-tune geometry alignment border line position to get perfect result.
  - ✓ Select CH-2 (RH projector), execute the same procedures as CH-1 to finish black level uplift procedures.

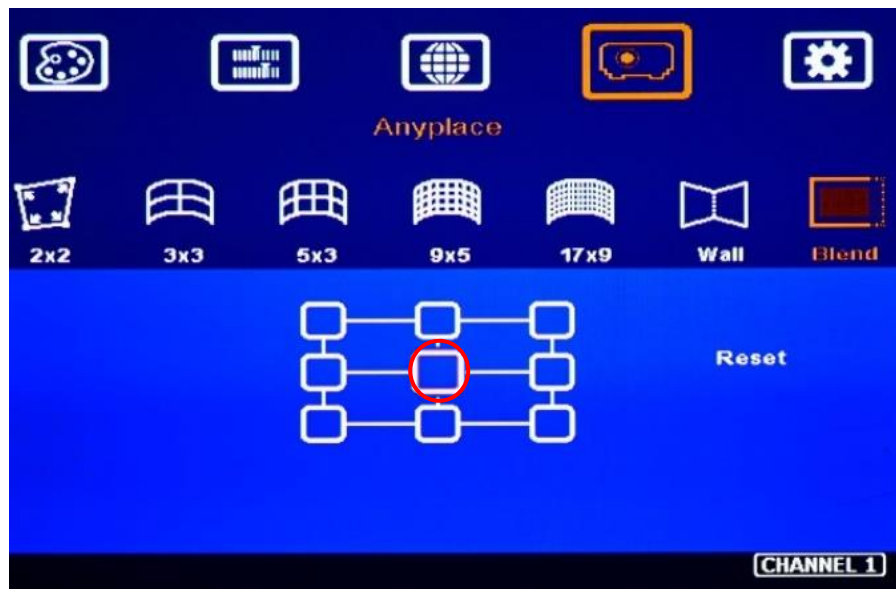

## 6.5. [Color]: Individual projector white balance and color correction

The [Color] function can be applied to individual projector for white balance and color difference correction through separate RGB Gain and Offset adjustment. It will be helpful to compensate projector color difference, lamp brightness decay and lamp replacement issue. It can't compensate the color banding in edge blending region. Edge blending color banding is mainly caused by gamma curve setting in the projectors.

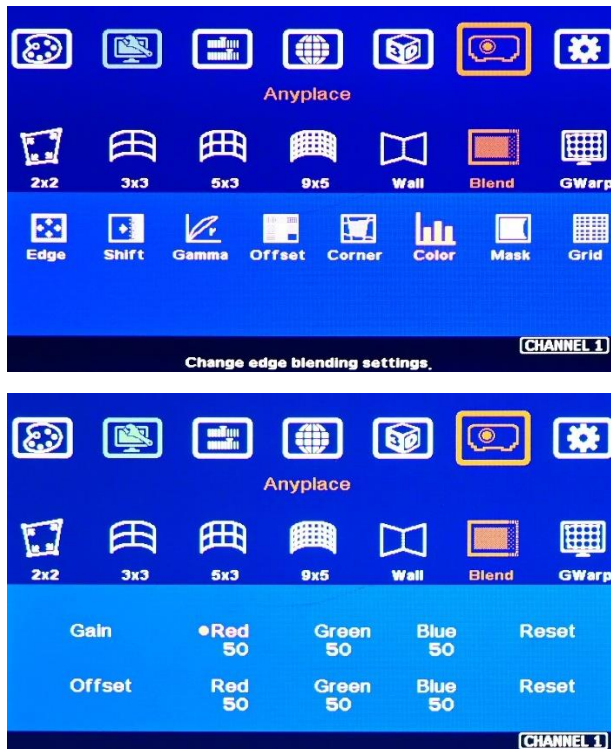

- Under [Color] menu, user can adjust separate RGB [Gain] and [Offset] value to change the color and white balance in each projector.
- [Gain] is to change the color slope and take more effect in brighter region.
- [Offset] is to add value in all level of brightness (0-225) and take more effect in darker region.
- When apply [Color] adjustment, it will affect entire color in the projector. Please check with different video contents and minimize the side effect.

In edge blending procedures, user needs to adjust the color from projector first. If it is still not enough, user can use [Color] function to do further adjustment. Please note that, any color adjustment will reduce the color dynamic range. User needs to check the result with full range color image.

## 6.6. Edge [Mask]

There are two edge mask functions in G810. One is image [Shift] and another one is Edge [Mask] under Edge blending menu.

- [Shift]: Able to do edge mask with black background in each edge up to 500 pixels.
- [Edge Mask]: There are 8 control points for edge mask. When user moves the position for each control point, it will result various edge mask effect. The maximum position adjustment for each control point is +\_ 900 pixels in H&V directions.
- The starting point for [Shift] is based on the image position after geometry alignment and the starting point for [Mask] is calculated from the original edge position before geometry alignment.

- When implement edge mask, OSD menu will be also masked. To imlement through GCT will be more convenient without OSD masked issue.



Original Image after geometry alignment

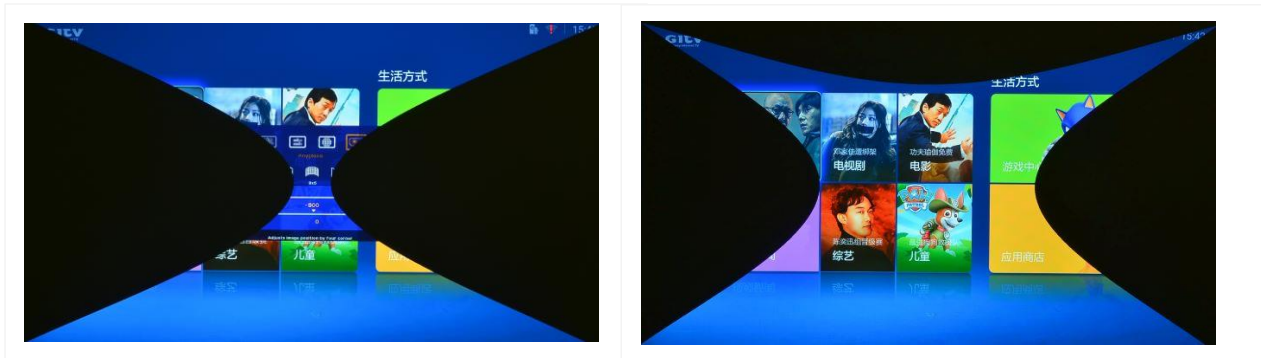

Image [Shift] (Follow geometry curve)



Image [Mask] (executed by 8 control points)

### Another Image [Mask] example



## 6.7. [Grid] (Determine grid pattern size)

The pixel size in grid pattern for geometry alignment is selectable. The grid size is from 8 to 120 pixels with 1-pixel increasement in both horizontal and vertical directions. H&V grid size will be the same. User can select grid size under [Edge Blend] menu. Default grid size for both H&V directions are 32x32.



## 6.8. Final image quality fine-tune

- The final performance will be a combination of many factors—projector characteristics, projector setting, screen, ambient light and GeoBox setting.
- Banding in overlap area under dark environment is caused by light leakage in the projector optic system. User needs to uplift the black level in none overlap area through [Offset] menu.
- The projector may retain light leakage near the border (about 20 pixels) of the imager (micro display—DMD, LCOS or LCD). It is not possible to be fixed.
- The factors affect final image quality
  - ✓ Projector:
    - To select projector display mode near 2.2 gamma setting will get the best result.

- 
- Ultra-short throw ratio projector is not recommended for edge blending, especially in curved screen edge blending.
  - When using ultra-short throw projectors, the reflection angle in overlap area will be very big. Viewer will see different color banding when watch the image from different viewing angle especially the screen gain value is more than 1.0.
  - To reserve enough overlap area—0.6m-1.2m in width or 20%-40% (based on single projector native resolution) is recommended.
  - To adjust image position of the projector and reduce keystone angle.
  - Increase Overlap region & reduce off axis angle
  - To reset projectors with the same settings.
  - To select Display Mode. Usually Standard, sRGB/Neutral will get better result.
  - To disable projector Brilliant color adjustment or Auto/Dynamic color adjustment.
  - Try different color settings in the projectors.
- ✓ GeoBox settings:
- Edge Blending Gamma settings:
    - ♦ To execute [Transition] Gamma adjustment: start from one color in one channel first. After see some difference, then adjust other two colors. Try to do the same in the second channel.
    - ♦ [Gain] Gamma adjustment: if Transition Gamma adjustment still can't fix the issue, try to adjust Gain Gamma. It will change gamma curve in each projector. Starting from one channel in one color first, then to do other two colors adjustment.
    - ♦ [Offset] gamma: When implement black level uplift, [Offset] gamma can change the brightness in overlap region borders if some brightness gap happens between overlap and non-overlap areas.
  - [Shift] adjustment: If user sees dark line at the edge of the overlap region, to adjust few pixels (1-10) at “-“ value will change the color at the border.
  - [Color] under [Blend] menu: If user sees background color difference when apply pure white image, user can adjust [Color] to balance background color difference.
  - Image Properties: To select Preset Mode to Neutral or Bluish may improve banding condition but it will change whole image color temperature.
- ✓ Screen: To use lower gain value screen.
- Low gain value screen will improve banding effect in overlap region but will reduce total image brightness.
  - Short throw projectors with high gain screen may cause banding effect when watch from different viewing angles due to different reflection intensity.
  - User needs to carefully select the transparent screen for projection from rear when using ultra-short throw ratio projector. Due to big reflection angle, the transparent screen should be test before installation.

## 7. Example for 3 projector edge blending procedures

A Curved Screen Edge Blending tutorial video is available in the website at <https://youtu.be/pn6XQiNpdLc>. Please check.

### 7.1. Get detailed edge blending information through VNS Excel Spread Sheet

#### 7.1.1. Assumption

- Required image size (screen size): 6.5m\*1.5m
- Watch distance: 2m (pixel pitch should be less than 2mm)
- Input signal resolution:
  - Horizontal resolution:  $6.5\text{m} / 2\text{mm} = 3250$ . It means minimum input resolution shall be  $H > 3250$ . 3250 is not VESA standard resolution. Therefore, we select 3840 as horizontal resolution. The ideal vertical resolution is based on screen aspect ratio:  $6.5/1.5 = 4.33:1$ .  $3840/4.33 = 886$ . It means 3840\*886 is the resolution without image distortion.
  - In actual application, user can select 3840\*886 from PC signal source. The media player and other display playback devices may have no 3840\*886 output. User can select 3840\*800 (same as projector vertical resolution) or 3840\*1080 (or 3840\*2160). Once user set a full screen display in the complete system, user still can see no distortion image.
  - User needs to prepare a content with 4.33:1 aspect ratio to avoid image distortion.
- Number of projectors: 3 projectors at 3x1 horizontal position
- Projector resolution and lumens. 1280\*800 (native resolution), 3200 Lum. GeoBox output resolution shall be the same as projector native resolution to get the best video quality.
- Overlap pixels and dimension. 8 grids= $8*32 = 256$  pixels
- Projector throw ratio: 1.2-1.7 (based on projector spec)

#### 7.1.2. Excel calculation

- Input the data in yellow column. User will get calculation result.
- Final image size for each projector: 2.500m\*1.563m
- We reserve 6cm image height for geometry alignment and after service. User can use geometry alignment to draw the vertical height to the required dimension 1.5m.
- Optimized content resolution: 3328\*800 (This is the ideal resolution for the content and EDID).
- Installation distance: 3m-4.25m (based on throw ratio 1.2-1.7).
- The value in video wall Overlap setting:
  - #1 Projector: RH edge: +197
  - #2 Projector: LH edge=+98, RH edge=+98

- #3 Projector: LH edge: +197

➤ The final luminance is 819 Lux. It will be enough for indoor environment.

#### Project basic data

Source resolution (H)	3840	Screen width	6.50	(m)
Source resolution (V)	800	Screen height	1.50	(m)
Projector resolu. (H)	1280	Projector lumen	3200	(Lum)
Projector resolu. (V)	800	Screen Aspect ratio	4.33	(required)
Overlap pixels (32 pixels per grid)		Overlap %	Recommended	
Overlap pixel (H)	256	20.0%	20%~40%	
Overlap pixel (V)	0	0.0%	25%~40%	
Recommended overlap region: Min. 50 cm width				
Qty of projector (H)	3	Throw ratio (Min)	1.20	
Qty of projector (V)	1	Throw ratio (Max)	1.70	

#### Final output resolution

Horizontal resolution	3328
Vertical resolution	768
Extended pixel (H)	98
Extended pixel (V)	0

#### Video wall setting value

Position of projector (H)	1	2	3	4	5	6	7	8	9	10
LH edge overlap value	0	98	197	x	x	x	x	x	x	x
RH edge overlap value	197	98	0	x	x	x	x	x	x	x

Position of projector (V)	1	2	3	4	5	6	7	8	9	10
Top edge overlap value	0	x	x	x	x	x	x	x	x	x
BTM edge overlap value	0	x	x	x	x	x	x	x	x	x

#### Final result checking list (PJT: Projector)

Final Image size (meter)		Final Illuminance Lux (Lum/m2)		Image size for each PJT	
Width	6.50	PJT lumen	3200	Width (m)	2.500
Height	1.56	Final Illumin	819	Height (m)	1.563

Overlap region size		Original aspect ratio		Projector throw distance	
Horiz. (m)	0.500	Projector	1.60	Min (m)	Max (m)
Vertic. (m)	0.000	Final result	4.16	3.00	4.25

\* Final image height should be equal or larger than screen. User can shrink image to have the same image height as screen by GeoBox geometry adjustment.

\* Standard luminance is 400-800 Lux for restaurant and big conference room, 1000-1500 Lux for trade show. 3D: 500 Lux (single projector)

## 7.2. Mark image location and install the projectors

- After Excel Spread Sheet calculation, user can understand the final image position for each projector based on the image size for each projector and the overlap region dimension. Please mark image position by paper adhesive tape on the screen. The positions should include 4 corners of the image for each projector and horizontal center line of the screen. Laser level is an ideal tool for marking center line, horizontal and vertical image positions.
- Please install the projector just enough to cover the required area with minimum keystone in both sides.

## 7.3. System connection

- Only the input signal from HDMI-1/HDMI-3 input port can be looped out.
- Input signal can be connected to HDMI-1/HDMI-3 input port and looped out to next processing module.
- If setup by IR remote controller, please install IR extender near screen for easy access by remote controller. The maximum adjusting points is 9x5.
- User can setup GeoBox through Ethernet. Please use WebGui or GCT PC tool for the setup. GCT can implement up to 17x9 adjusting points.
- Select input port and set GeoBox output resolution to be the same as projector native resolution.

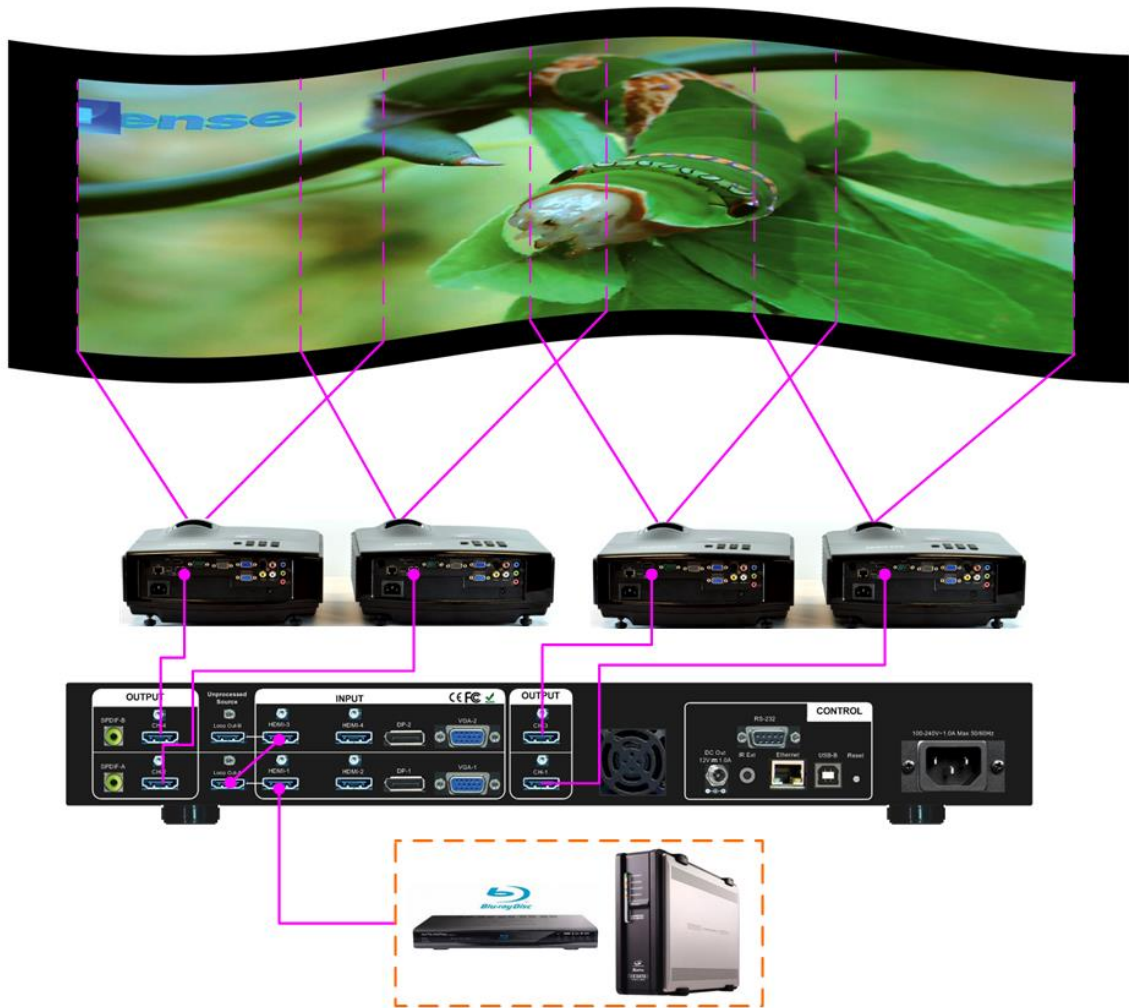

#### 7.4. Projector settings

- Please reset projector to default setting.
- Disable dynamic color adjustment.
- Disable Auto Keystone function.
- To select a Display Mode with 2.2 gamma curve will reduce the color difference in overlap area. If necessary, please choose a Display Mode with the best result.
- Use projector internal color adjusting function to adjustment the color variation among projectors before implement edge blending.
- Install projectors at a place with image size that can cover required image area and with minimized keystone to get the best video quality.

#### 7.5. GeoBox Settings

- Reset GeoBox to default setting.
- Select input port.

- Select output resolution to be the same as projector native display resolution.
- Check input/output LED indicators and make sure to have correction system connection.
- Disable [Frame Sync] function to eliminate Source re-search in the projector while executing GeoBox system setup through [Options]→ [Setting]→ [Frame Sync]→ [Disable]. Please return to [Normal] setting after edge blending.
- If setup via Ethernet, please connect GeoBox with Switch/Hub or WiFi router in LAN port.

## 7.6. Geometry alignment

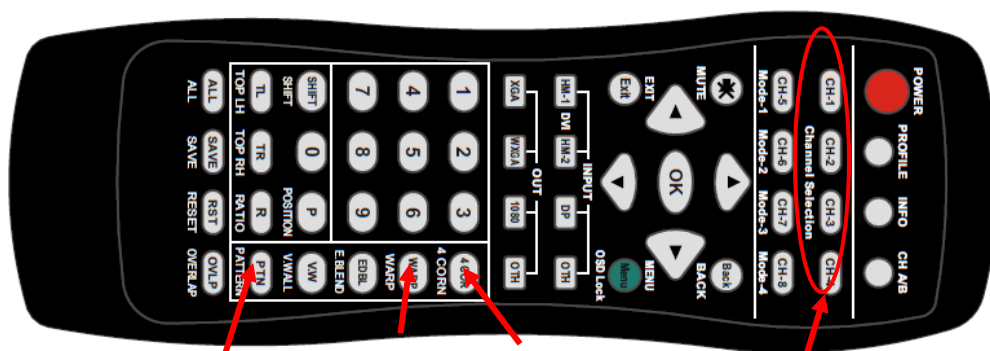
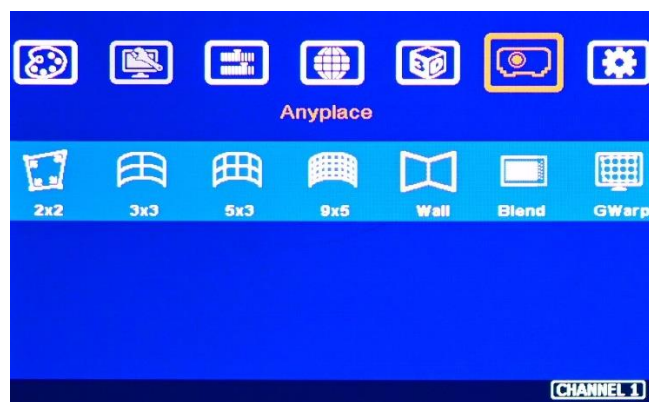

Grid pattern

Warp ([3x3], [5x3], [9x5], [17x9])

[2x2] (4 corner alignment)

Channel selection

- User can install IR extender receiver near screen for easy GeoBox operation. IR receiver extender can be extended through audio cable.
- Click channel selection key and [Pattern] key to show grid patterns in all projectors. Press [Pattern] key again will change grid color. To set different pattern colors in adjacent projectors will be more convenient for geometry alignment.
- Please follow the sequence [2x2]→ [3x3]→ [5x3]→ [9x5]→ [17x9] to do geometry alignment to ensure entire image will have uniform scaling factor.

- 
- Apply [2X2 Corner] geometry alignment and draw the corners to expected locations. It doesn't matter to have some image inside the screen once it covers entire screen before 4 corner adjustment. [Warp] alignment will adjust the image position back to the required position.
  - If user doesn't execute VNS Excel Spread Sheet calculation, please use [2x2] alignment and try to let all projectors have similar image size with the overlap area having the same grid number.
  - Apply [3x3 Curved] geometry alignment to let 9 adjusting points be located at the required position including four corners, edge center points and center line position in each projector.
  - Please use [5X3] & [9x5] for further geometry alignment and fine-tune. Linearity Grid Line adjustment function is convenient for complete grid line movement.
  - After finish the alignment, user can use [2x2] for complete image position fine tune. If user executes [3x3] alignment again after [9x5] alignment, [9x5] grid position will be reset and only keep [3x3] grid point information.
  - In ideal condition, all grids in edge blending area between two adjacent projectors should be aligned together.
  - After the above processes, if the grid pattern in edge blending area still can't stack together, user can reduce or increase overlapped grids to change the control point positions in adjacent projectors and get more accurate geometry alignment result.
  - [GCT] PC tool can provide 17x9 grid point adjustment with quicker geometry alignment.
  - After finish geometry alignment, all grids should be matched together.

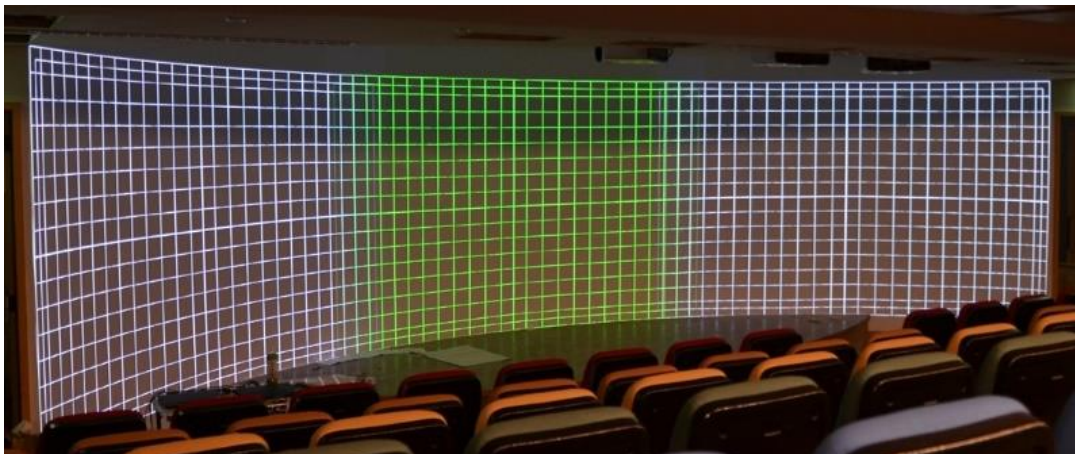

7.7. Video Wall settings

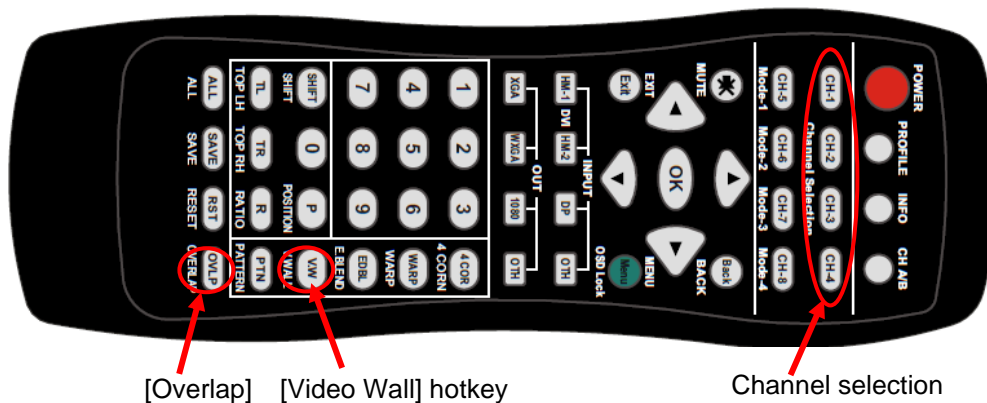
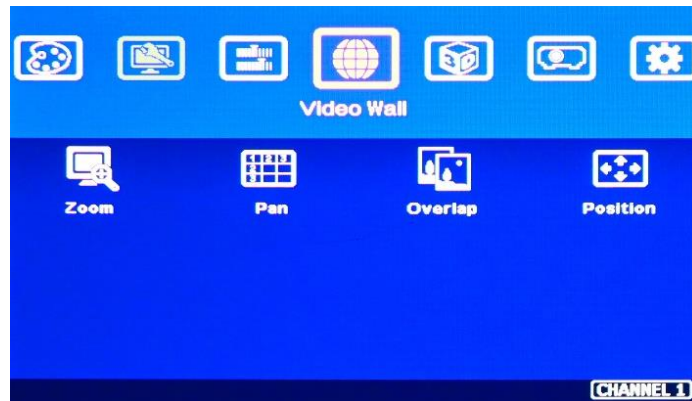

- Click [INFO] key to check if correct input and output timing is in the system. User needs to apply the same input/output timing as VNS Excel Spread Sheet calculation.
- Example for [Video wall] settings for 3 projectors horizontal edge blending with one G810:
  - ✓ [Zoom]: set to H=3, V=1 in all channels. Each channel should be set separately.
  - ✓ [Pan]: LH projector (1st): H=1, Center projector (2nd): H=2, RH projector (3rd): H=3. All projector Vertical PAN is the same: V=1.
  - ✓ [Overlap]: select the correct edge and apply the value calculated from VNS Excel Spread Sheet: LH projector: RH edge, Center projector: both RH/LH edges, RH projector: LH edge
  - ✓ Below is overlap value calculated from VNS Excel under below condition:  
 Input: 3840\*800, Output: 1280\*800, Overlap pixels: 256, Projectors: 3  
 Horizontal Overlap value: Projector 1 RH edge= 197, Projector 2 RH edge= 98, LH edge= 98, Projector 3 LH edge=197  
 Vertical values in all projectors are set with the same "V=0".

### Video wall setting value

Position of projector (H)	1	2	3	4
LH edge overlap value	0.0	98	197	x
RH edge overlap value	197	98	0.0	x

Position of projector (V)	1	2	3	4
Top edge overlap value	0.0	x	x	x
BTM edge overlap value	0.0	x	x	x

- For dual projector edge blending, user can apply still image, select correct edges and adjust [Overlap] value simultaneously and let the image in edge blending area comes closer till without double image. Two projectors shall have the same value (same cropping range). The difference shall not be over 2 pixels.
- If no Excel is available for overlap calculation, user can apply VNS Video Wall test pattern on the screen, then adjust the complete pattern to let entire pattern match together by overlap adjustment.
- If user still sees some blurred image in edge blending area, please increase or decrease [Overlap] value in [Video Wall] setting to improve video quality.
- Please note that projector has Thermal Drift issue (position shift due to different temperature). The image position in power ON stage may be different from the position after 15-20 minutes when the position is stable. Don't adjust image position during this period until it is stable.

## 7.8. [Edge Blend] setting

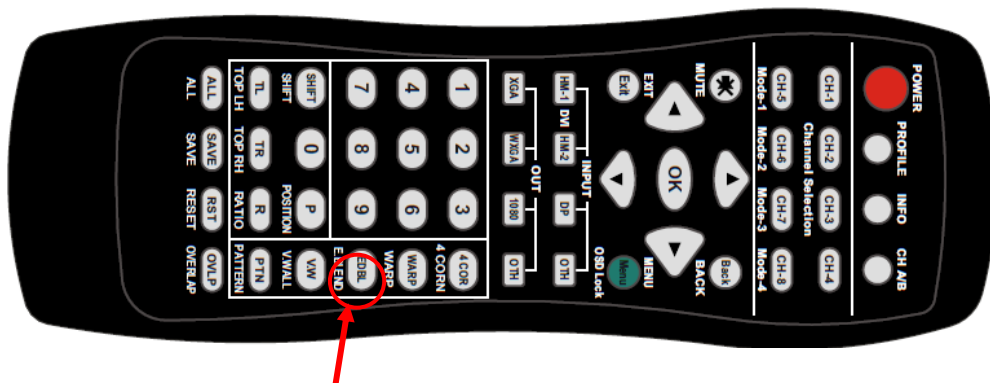

[Edge Blend] hotkey

- Select correct Edge for the edge blending:  
LH projector: RH edge, Center projector: RH & LH edge, RH projector: LH edge
- RED and GREEN indicating lines will appear when increase edge blending pixels. The final overlap setting value will be the same as Overlap pixels (256) in this example case.
- User needs to adjust the color indicating lines to match together (green to green, red to red) and will see a smooth image

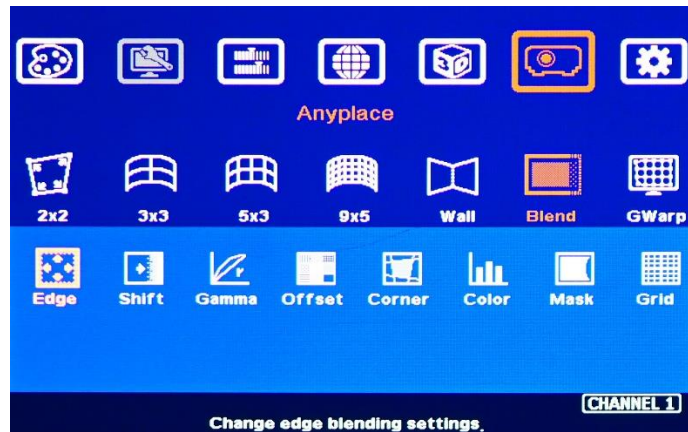

## 7.9. Final Image quality fine-tune

- If banding effect is visible in overlap area, please try below method:
  - ✓ GeoBox [Gamma]: Please try to adjust Gamma value in [Transition] & [Gain] menu and adjust [Shift] value to " - " to do color uplift in the edge of overlap region.
  - ✓ Projector: please try to change projector settings
    - All projector should have the same setting.
    - To select color profile with gamma 2.2 will get the best result.
    - Check Display Mode: Usually Standard, sRGB modes will get better result.
    - Disable projector Brilliant color or Dynamic color adjustment.
- The video quality in overlap region is related to many factors. Please see more details in other section related to [Final Image quality fine-tune] in this user guide.

## 8. Save/Load System Settings

- After finishing system settings, user can save the setting via OSD menu through [Menu]→ [Options]→ [Setting]→ [Profile]→ [Save]→ [Index 1-5]. It will take effect for one channel only. User needs to save each channel separately.

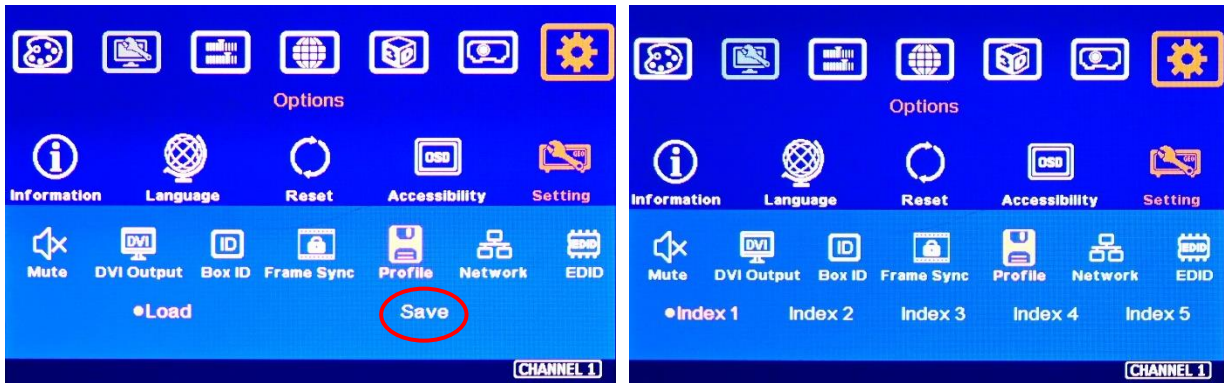

- User can save the settings through [Save] hotkey on remote controller. It will take effect for all channels at the same time.
- [Save] function is also available in WebGui and GCT. It will take effect for all channels.
- Please save all channels into the same Profile Index for easy Load back at the same time.
- Five different display settings can be saved to [Profile]. The data stored in Profile include EDID setting, input source, output resolution, color settings and all user customized settings.
- User can [Load] the settings through below methods:
  - ✓ OSD menu: [Menu]→ [Options]→ [Setting]→ [Profile]→ [Load]→ [Index 1-5]. It will take effect for one channel only.
  - ✓ Remote controller [Profile] hotkey: Press [Profile] hotkey, then select number keys on the remote control (not through OSD direction keys) to [Load] user settings. It will Load the settings for all channels at the same time.
  - ✓ WebGui & GCT: user can access [System]→ [Load] menu to recall the settings for all channels through Ethernet or USB (GCT only).
- When user power off the system, G810 will save user setting without loss even the setting is not saved into Profile Index, unless someone to change it.
- Under below conditions, the settings data inside Profile Index will be kept without missing:
  - ✓ When system has been reset from OSD menu, it will take effect for one channel only and the Profile data will not be deleted.
  - ✓ Remote controller [Reset] hotkey will take effect for one channel and Profile data will be kept without delete.
  - ✓ When user update new Firmware, it will not affect Profile data.
  - ✓ Only Reset from reset hole on back panel will erase Profile Data.

- Hotkeys for Profile [Save] and [Load]

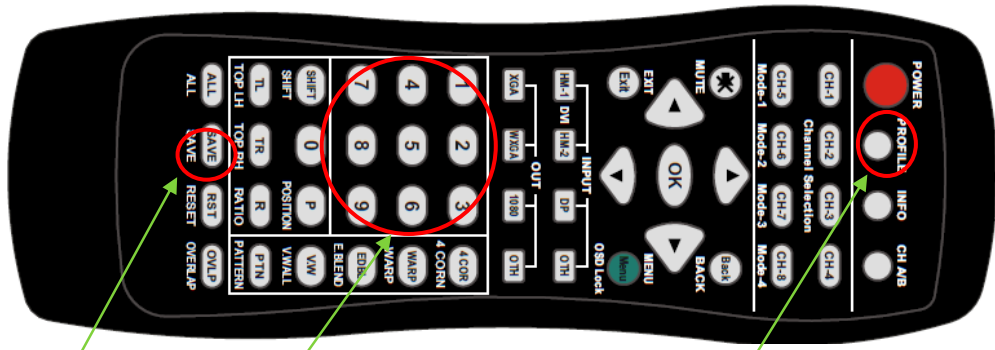

Press [Save], then select number key to save settings. The setting will apply to all channels at the same time

Number keys (1-5) for Profile [Save] & [Load]

Press [Profile] hotkey, then select number keys (not through OSD direction keys) to [Load] user settings

## 9. Multiple unit applications

### 9.1. System connection in multiple unit edge blending

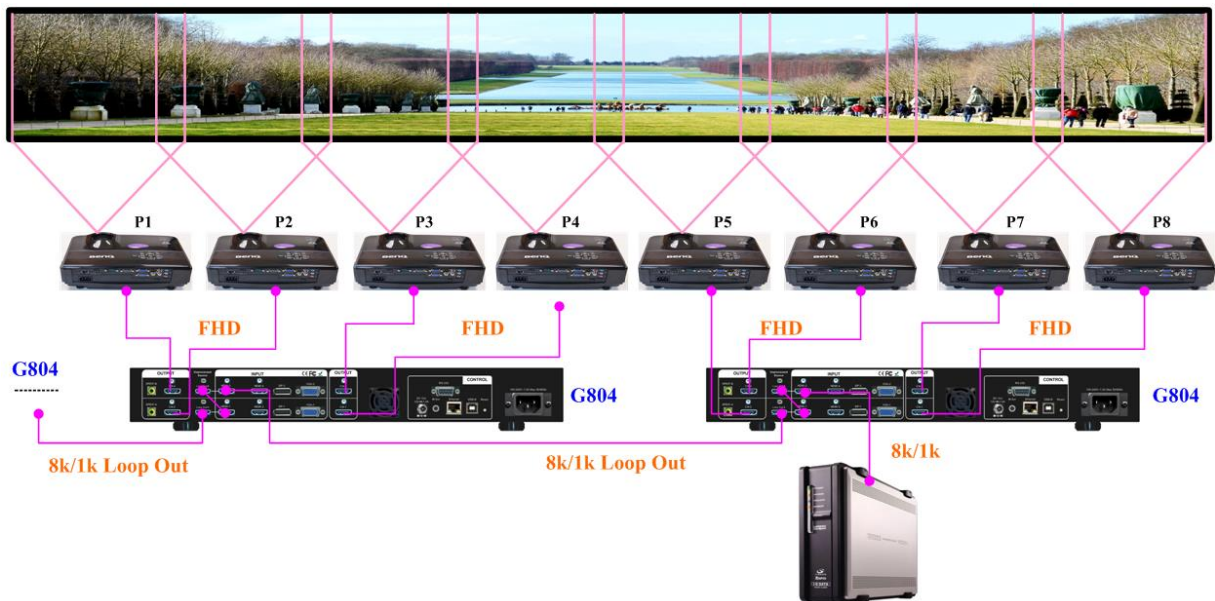

- Connect input signal to G814 HDMI-1 or HDMI-3 input port and looped out to second processing modules, then connect the last loop out port to next unit. No special sequence is required.
- Usually, loop out signal can connect up to 10 processing modules. The maximum number is related to signal resolution and HDMI cable quality. If more channels are required, please add one HDMI splitter at the front end. It will extend to double or triple numbers of processing channels.
- In edge blending application, only HDMI-1 & HDMI-3 signals can be cascaded through internal HDMI splitter. If user wants to do edge blending with other input ports, please add video distributor

at the front end and feeds the signal to all G814 processing modules. Each G810 has 2 processing modules.

- User can control G814 through Ethernet, USB or remote controller.
- IF GeoBox is installed in control room, Ethernet control through WiFi will be the most convenient. Notebook, mobile phone and Pad can execute GeoBox setup through WiFi.
- User can set individual Box ID and IP address for easy independent control in each GeoBox.
- Select input port and set GeoBox output resolution to be the same as projector native resolution.
- User needs to apply a signal source while executing video wall [Overlap] value setting. Signal source resolution should be the same as VNS Excel Spread Sheet calculation. To apply 4K or higher signal resolution is recommended. After system setup, user can use any input resolution.
- Press [INFO] hotkey to check if the final in/out timings are the same as expected.

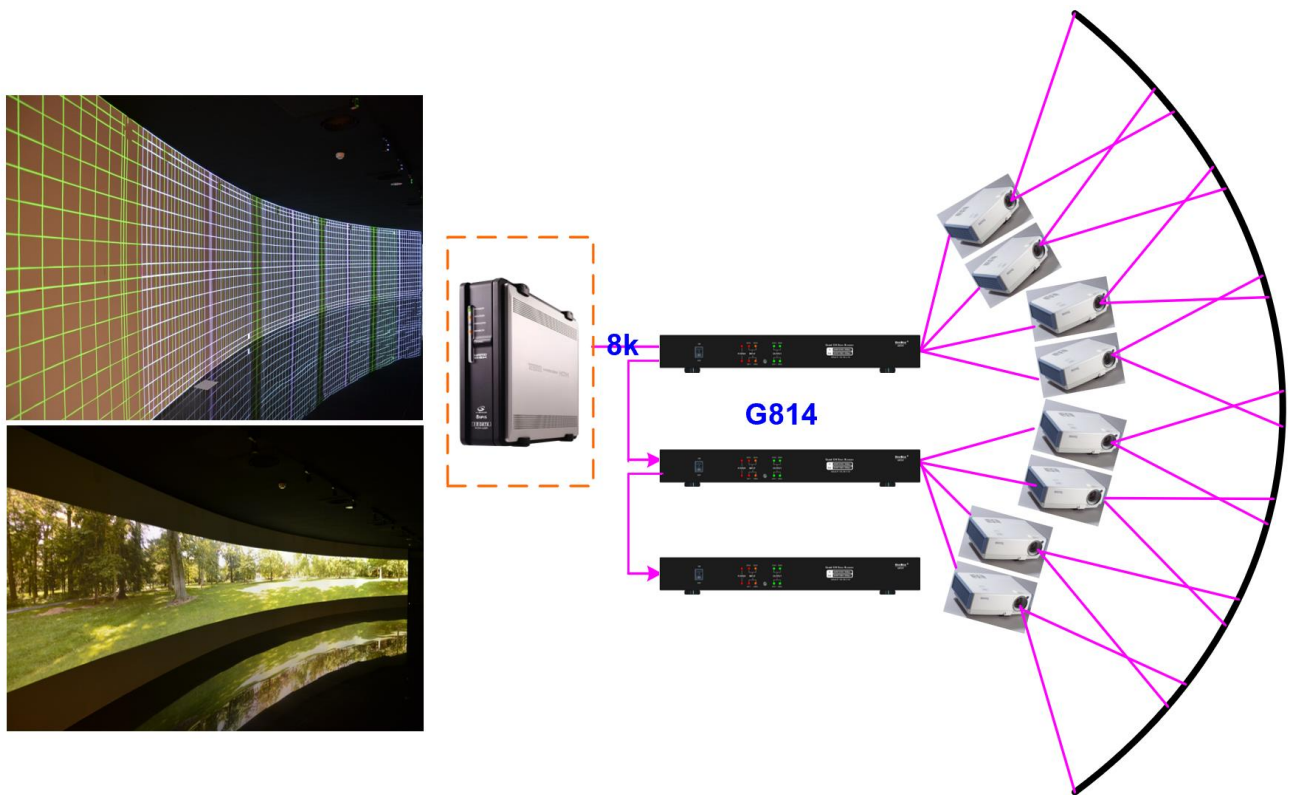

*Usually, one 4k signal source can be applied for up to 20 meters screen through 2x G814 & 8x projectors. If bigger screen is required, user can apply multiple signal sources through multiple synchronized media player or multiple output display card to achieve higher system resolution.*

## 9.2. Content overlap setting issue

If the system is larger than 20m, usually, multiple 4k signal source is required to get good enough video resolution. Below are some important points:

- User needs to split the content into different sections and each section is played back by one PC or media player.
- These PC or media player needs to be synchronized.
- GeoBox can crop the right overlap pixel inside one content for each projector but not for the pixel between two independent contents.
- The Overlap content between two independent signal sources shall be handles through below methods:
  - To set Overlap image through PC display card. In this case, the overlap cropping issue in this section will be handled by PC.
  - To cut the content with same content in overlap section for edge blending. The pixel size shall be larger than Overlap region and GeoBox can crop the right pixel for edge blending. User can use synchronized media player (such as BrightSign) or low-cost multiple output display card from PC.
  - Some PC display card can set overlap pixel up to 25% of the output resolution among the outputs. User can use display card similar to Matrox TripleHead 2 Go, ATI Display Group, NVidia SLI Surround or NVidia Mosaic mode.

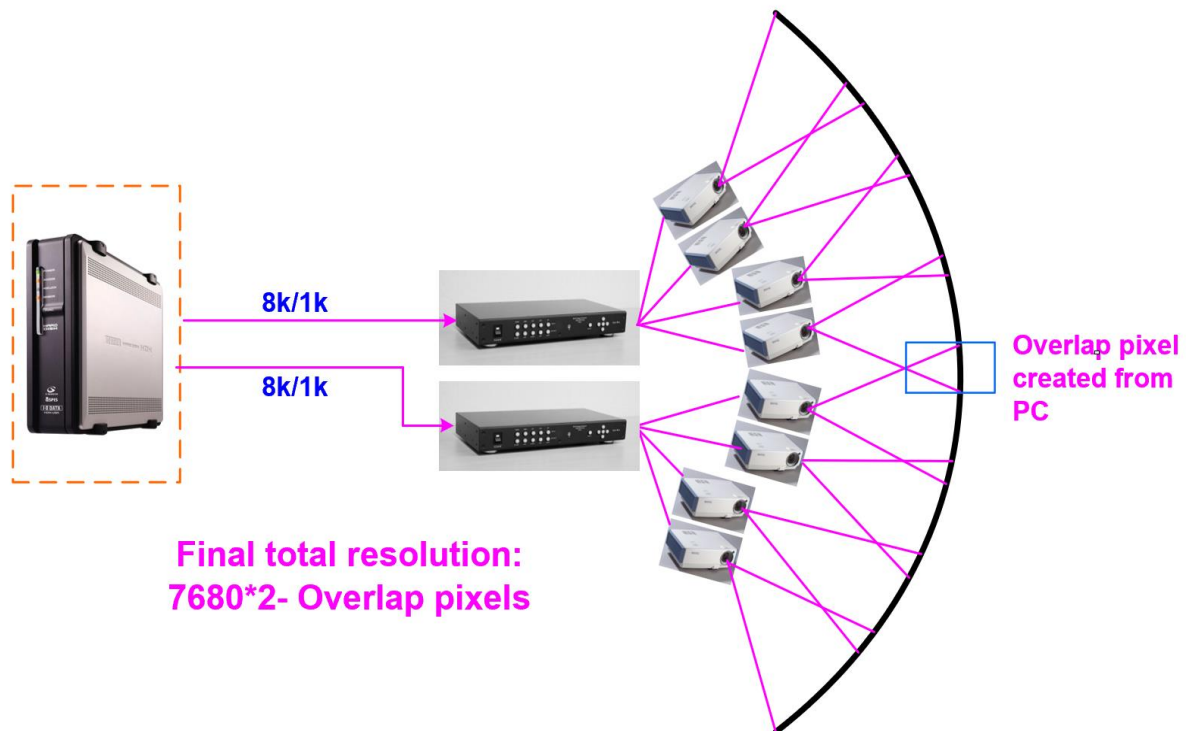

### 9.3. **Convenient Setting and PC tools in multiple unit application**

*Please see more details in [System settings: Box ID, RS232, Ethernet] section.*

#### 9.3.1. **Setup by Remote Controller**

- If multiple units are used, user can set different [Box ID] (#1 - #99) or IP address in each Box for individual control. For IR control, the [Box ID] number range is #1 - #9.
- When all G814 or IR extenders are installed together in the control range of single remote controller, user can do individual G814 control through below method.
  - Press [ 851 ] · all the box OSD will be locked except ID #1. The LED light will be flashing in the locked unit and only ID #1 can be operated through OSD menu.
  - Press [ 853 ] · all the box OSD will be locked except ID #3. The LED light will be flashing in the locked unit and only ID #3 can be operated.
  - Press [ 850 ] · all the box OSD will be unlocked and can be operated through remote controller at the same time.

#### 9.3.2. **Setup by Ethernet**

User can connect all G814 in one Ethernet Router (WiFi Router or switch/hub) through LAN ports and set different Static IP address for each Box, then use WebGui virtual keys or GCT PC tool to control each G814 independently. Default IP address is 192.168.0.100. TCP Server port is 1266.

## 10. WebGui and GCT PC tool

- WebGui is embedded inside GeoBox. Once user connects GeoBox through Ethernet IP address, user can see virtual key for the operation.
- GCT is standalone PC tool that can be downloaded from VNS Website. It is HID interface and can be controlled through USB or Ethernet. No software driver is required.

### 10.1. WebGui

- WebGui is embedded inside G814. Once user connects G814 with PC through Ethernet, user can access WebGui and execute all operation similar to OSD menu through Virtual Keys and OSD Menu. No appropriate software tool is required.
- The connection can go through Ethernet router LAN port, WiFi Router or Cat 5/6 cable. User can set each M810 with different static IP address in the same domain, then open Google Chrome or Microsoft Edge browser with IP address to access each unit of M810 for independent operation. There is no limitation in the number of M810 that can be controller at the same time.
- If the system is connected through UPT cat 5/6 cable between PC and GeoBox, user needs to manually set TCP/IPv4 with the same network segment such as 192.168.0.105 with subnet Mask at 255.255.255.0 and connect through Chrome or Edge.
- User can turn on/off the system through WebGui and see the status through power indicator.

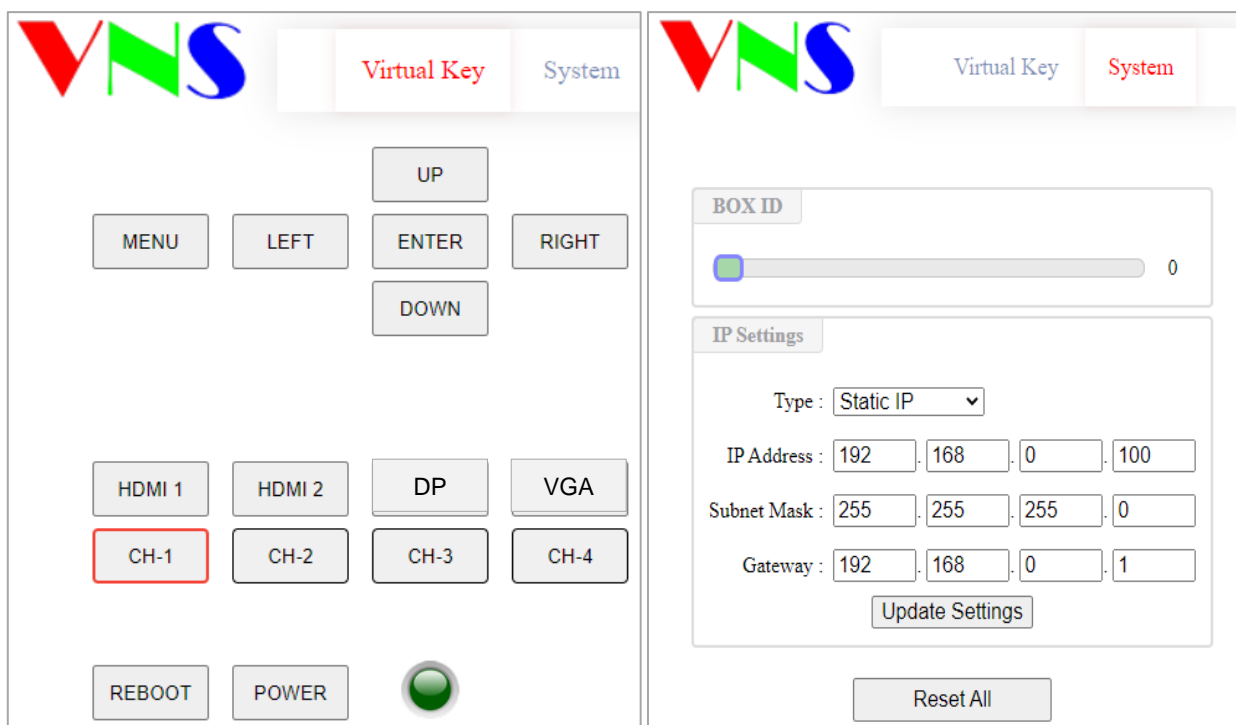

## 10.2. GeoBox Control Tool (GCT)

- GCT is a PC tool to control and setup M810 through PC.
- **Please download GCT PC and User guide from VNS website under SUPPORT tab.**
- GCT can be connected through Ethernet or USB. User can use PC keyboard and mouse for the control and can backup system setting in PC or copy to other units.
- Firmware and MCU code update can be executed through GCT. User can control multiple units at the same time through different IP address.

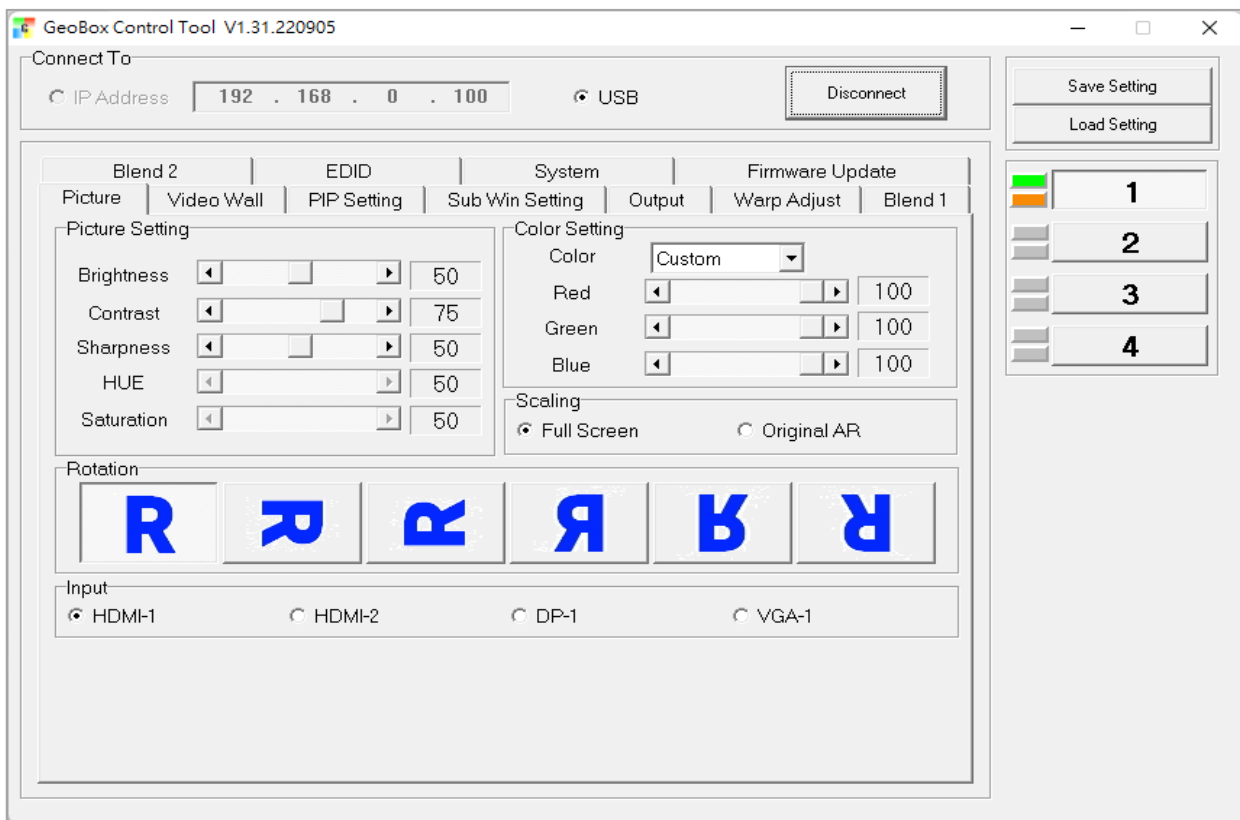

### 10.1.1. Important concept

- GCT can execute all the functions same as OSD.
- GCT and OSD adjustment is synchronized and will update to the Box immediately. User can control the Box via GCT and OSD at the same time.
- Besides the same functions as OSD, GCT can update Firmware and backup or copy the settings to other units.
- New GCT version needs to match MCU code and FW version. When user apply new GCT and see [MCU code is too old] message, please update new FW & MCU code. Please download from website under SUPPORT tab.
- When user turns off GeoBox, the settings will not change.

### 10.1.2. Procedures for edge blending via GCT

#### a) System connection

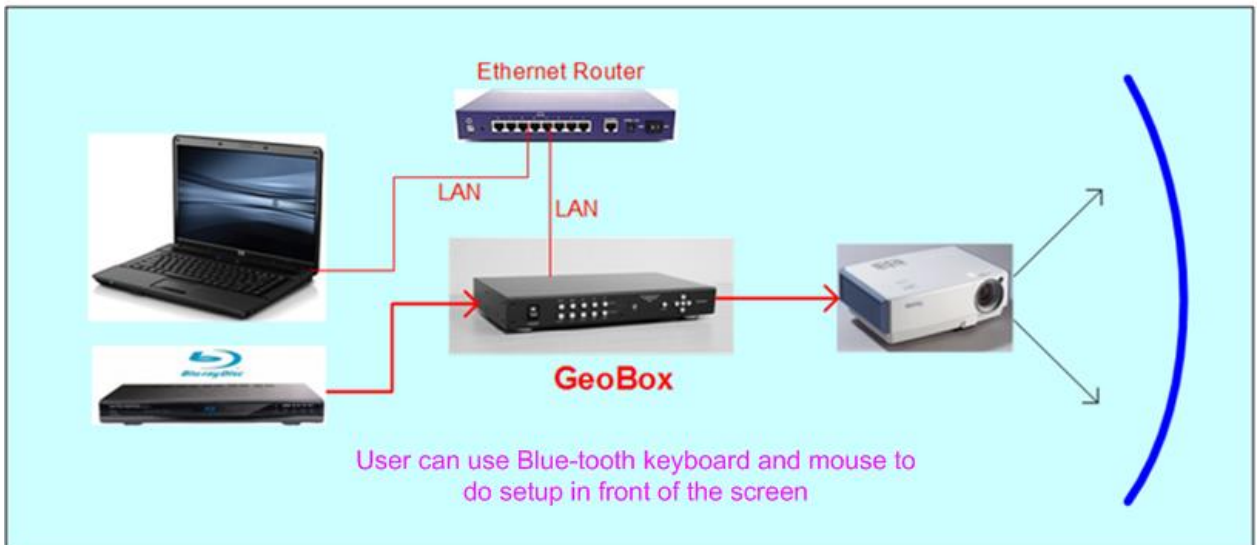

- (1) Ethernet: For multiple unit control, please user Ethernet Router for the connection with multiple boxes and set different IP address for the control.
- (2) USB: connect with USB-Type B cable.
- (3) Open GCT→ Click [Connect]→ user will see green and orange indicators at right hand side. It is to confirm the right connection with PC.

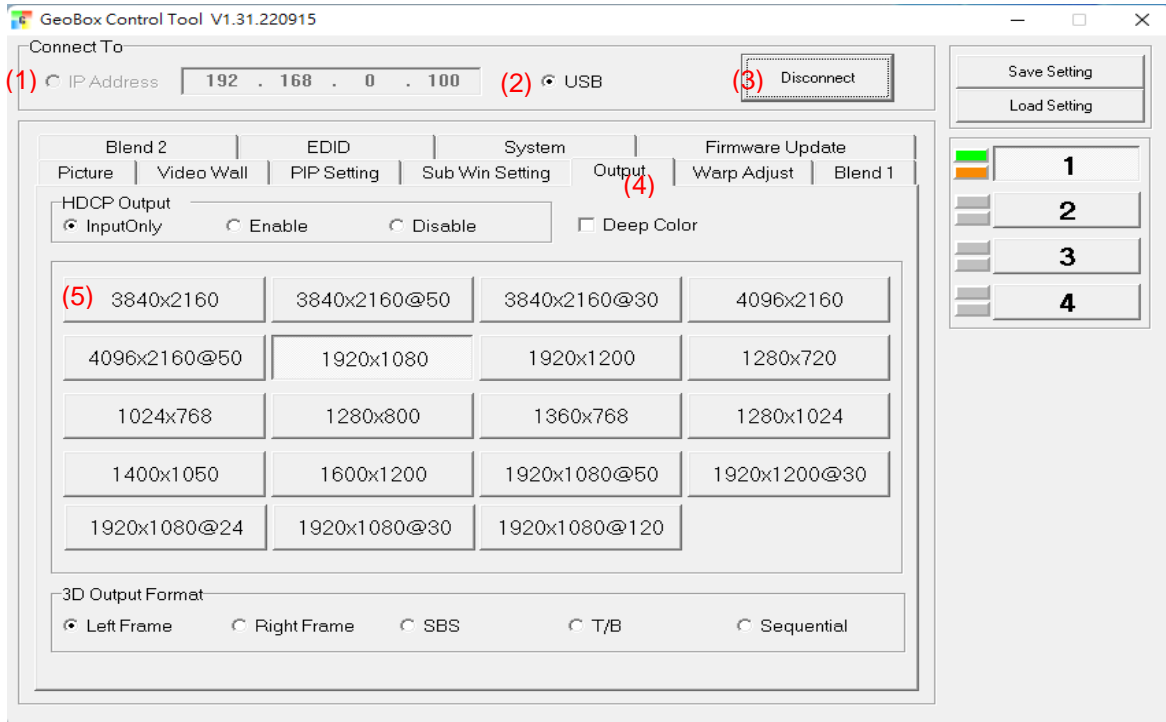

**b) Set output resolution**

- (4) Output resolution should be the same as projector Native Resolution.
- (5) Set required output resolution under [Output] menu.

**c) [Warp Adjust]: start geometry alignment**

All channels should execute geometry alignment at the same time to let grid lines perfect matching.

- (6) Click [Warp Adjust] to access below geometry alignment Menu.

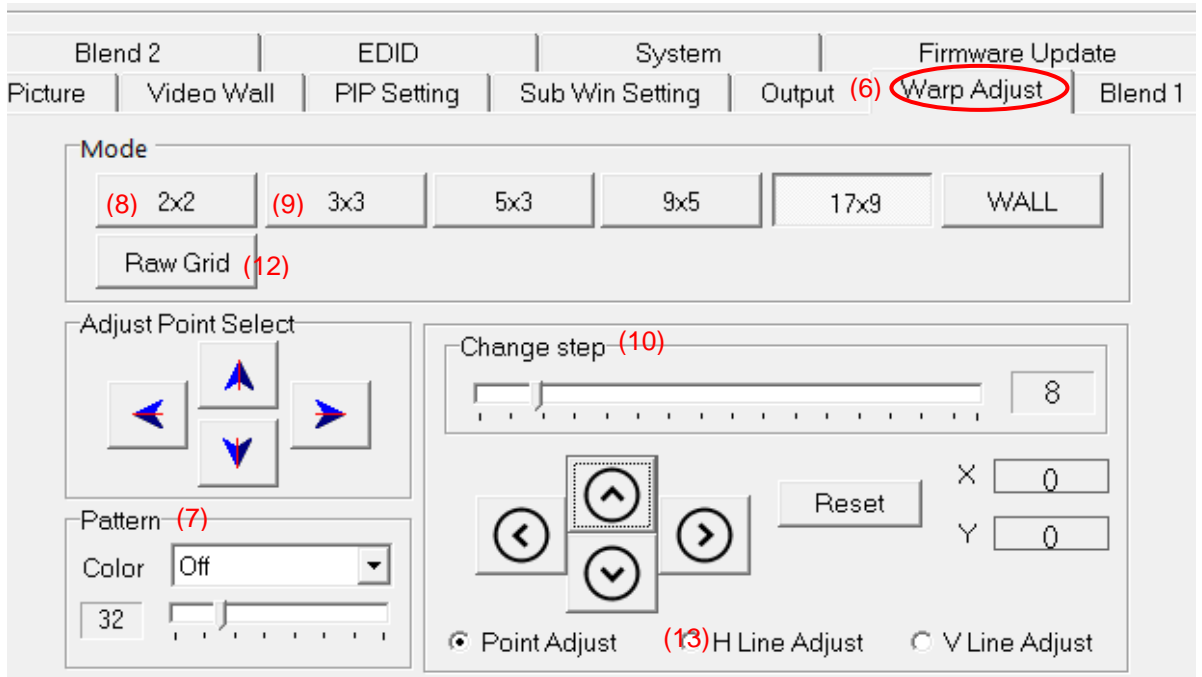

- (7) Select Pattern color for each channel. Adjacent channel should have different colors.

- 
- (8) Start from [2x2] geometry alignment in all channels and let the image in each projector to be located at desired (pre-marked) location.
  - (9) Following [3x3]→ [5x3]→ [9x5]→ [17x9] in all channels at the same time to let all grid lines in overlap area to be stacked perfectly.
  - (10) The adjusting step can be selected. User can also use keyboard hotkeys to select:  
[CTRL+Arrow]: 8 pixels/step. [SHIFT+Arrow]: 1 pixel/step
  - (11) If finish [17x9] alignment, user can return to [2x2] for further alignment but if return to [5x3], only [below [5x3] warp data will be kept.
  - (12) [Raw Grid] is for detailed position fine-tune after [17x9]. The maximum adjustment point is 100. After [Raw Grid] alignment, user can go back to [17x9] or [2x2] to do further adjustment. The adjustment points under [Raw Grid] adjustment will remain at the same location without changing by [2x2] or other alignment.
  - (13) When projecting to curved screen with short throw ratio projector, the image will have bigger grid size at the center and smaller at both sides. User can use Linearity Grid Line adjustment (13) to do the whole line movement. It will reduce the time for the adjustment. This function is available under [3x3] to [17x9] and in both horizontal and vertical lines.

#### d) **Keyboard hotkeys for geometry alignment**

Please set PC language in English so that user can use Keyboard hotkeys to execute system operation.

- [CTRL+ALT+#]: select channel
- [M]: Change circularly Warp Adjust mode from [2x2] → [3x3] → [5x3] → [9x5]→ [17x9]→ [Wall]→ [2x2]→ [3x3]...
- [CTRL + Arrow]: Select control point
- [Arrow]: adjust control point position, default is 8 pixels/step.
- [Shift + Arrow]: Geometry adjustment with 1 pixel/step
- [P]: Enable grid pattern with different color
- [CTRL + P]: turn OFF pattern to see OSD menu for the operation by remote controller
- [R]: Reset geometry alignment settings in current mode and channel.
- [U]: undo the last geometry alignment step.

#### e) **Save geometry alignment result temporarily**

- (14) Geometry alignment take the most of the time. After finishing geometry alignment, please save the result under [System]→ [Save Profile].

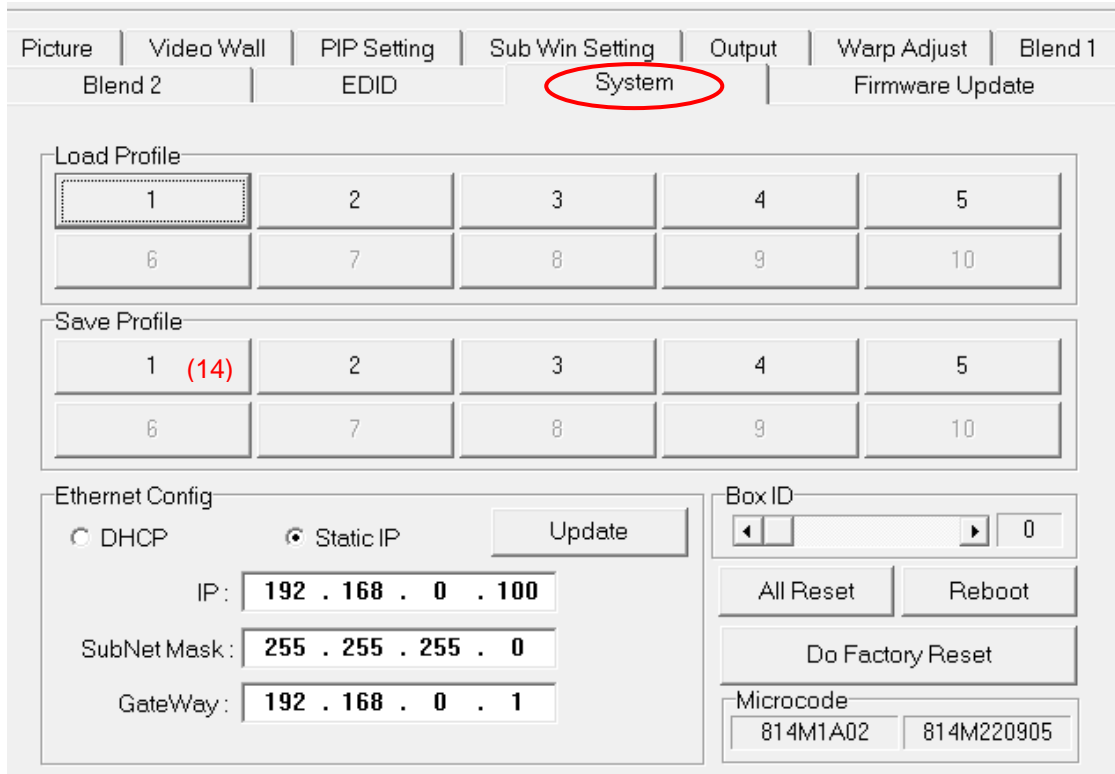

f) **Video Wall** settings

- [Video Wall] is to split the image and assign the location for each projector. It will also adjust the overlap pixels for related edges based on the overlap size.
- Please see detailed description in [Video Wall] section,

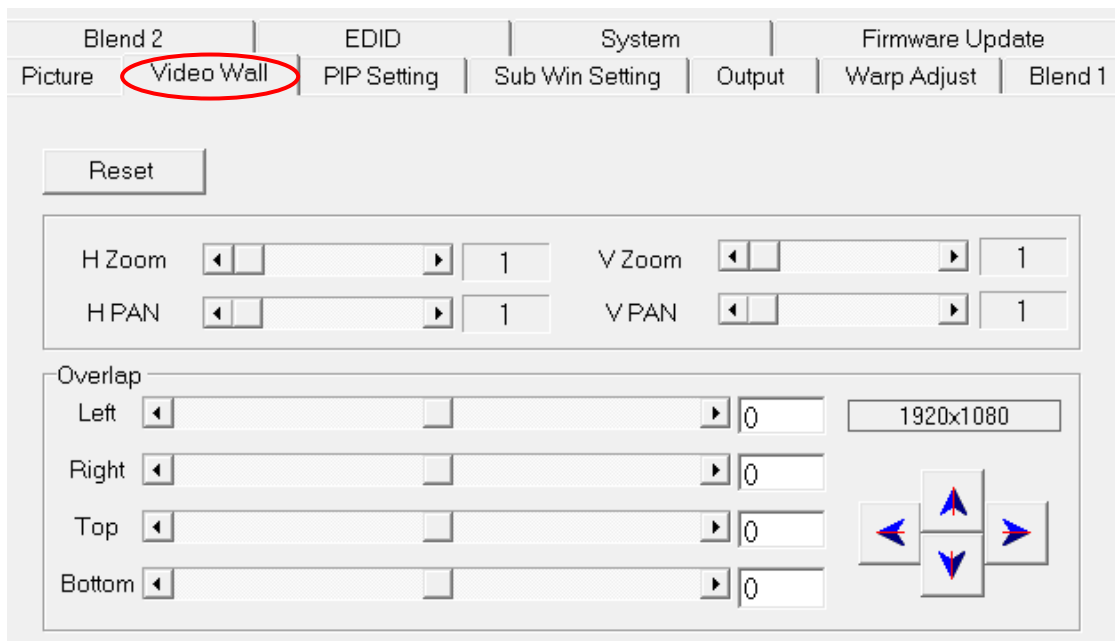

g) **[Edge Blend] setting**

[Edge Blend] is to set seamless edge blending effect between two adjacent projectors.

- (15) Click [Show Marker]: green and red lines will show up at both edges in edge blending each region. Please select the edge (16) for each channel and increase the value to let red line and green lines be stacked together. Please see detailed description in [Edge Blend] section.

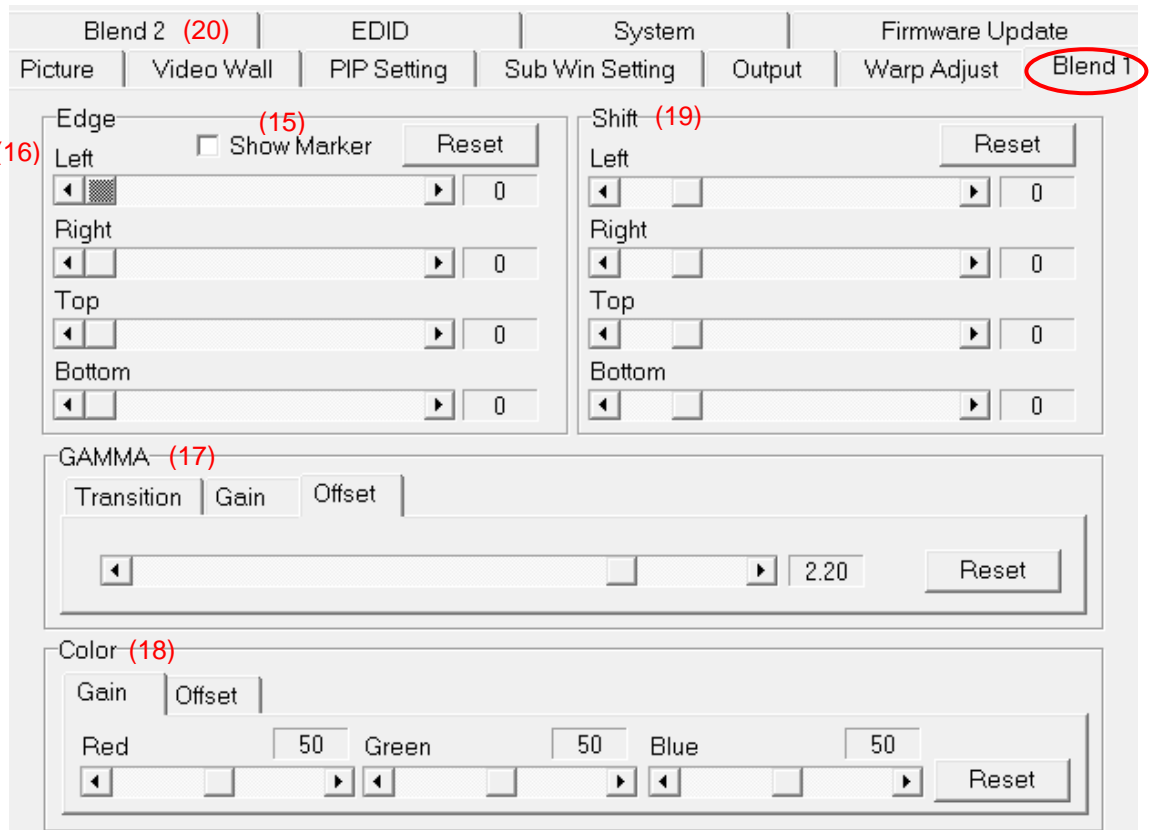

- (17) [Gamma]: for color fine-tune in overlap region.  
 (18) [Color]: for background color white balance adjustment.  
 (19) [Shift]: to shift edge blending position in overlap region or edge mask in non-overlap edge.  
 (20) [Edge Mask] and black level uplift is under [Blend 2] (20) menu

## h) Save final settings

User can save the final settings into two locations:

- (21) [Save Profile]: under [System] menu, user can save the final setting into profile index by selecting number in [Save Profile]
- (22) [Save Setting]: it will save current settings into BSF file in PC. It will not include Profile data. This data can be as a backup or copy to another box.

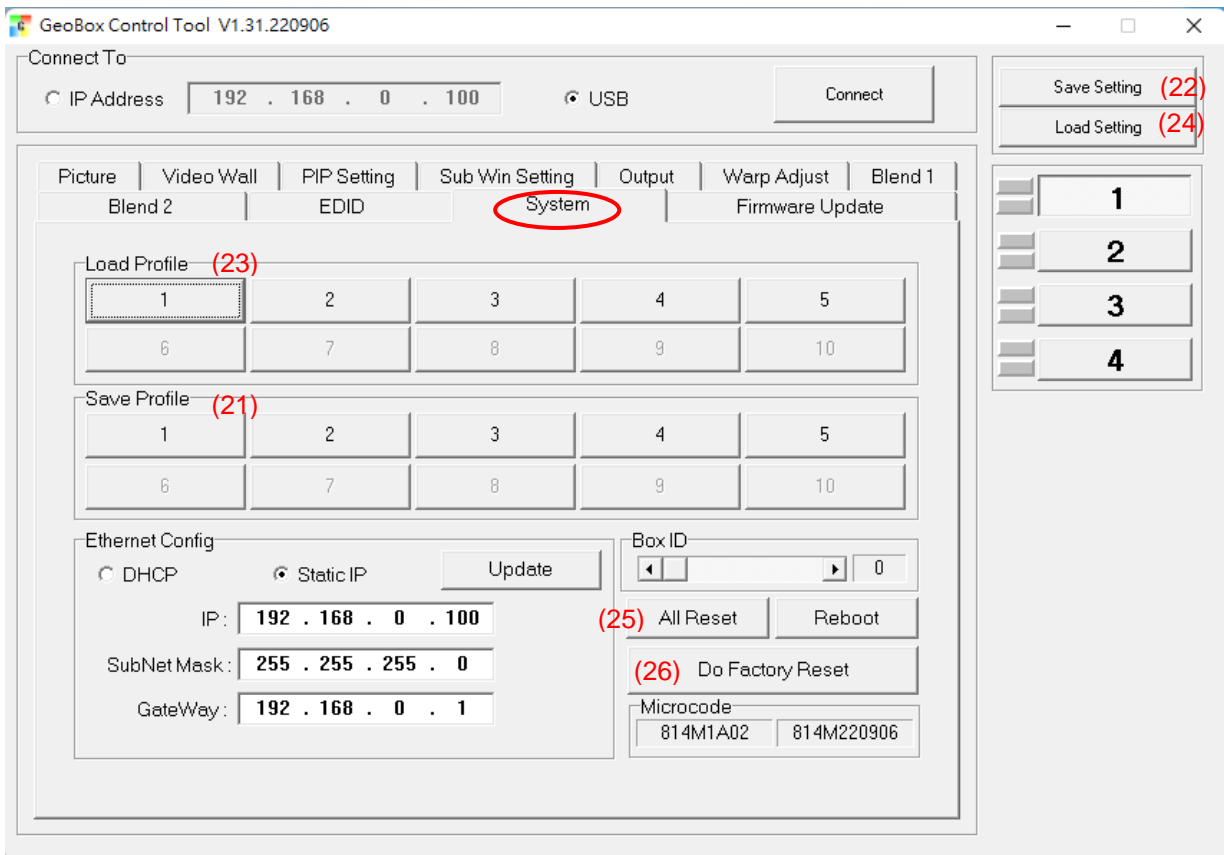

## i) Load back final settings

User can load back the final settings from two locations:

- (23) [Load Profile]: under [System] menu, user can load the final setting from profile index by selecting number in [Load Profile].
- (24) [Load Setting]: it will load the settings from PC BSF file. After load back the data, user needs to save it into Profile Index for permanent storage.

## j) System Reset

User can load back the final settings from two locations:

- (25) [All Reset]: Reset all channel at the same time but not include Profile Index data.
- (26) [Do Factory Reset]: reset the system to factory default including profile Index data in all channels. Same function as reset from back panel reset hole.

### k) Miscellaneous functions

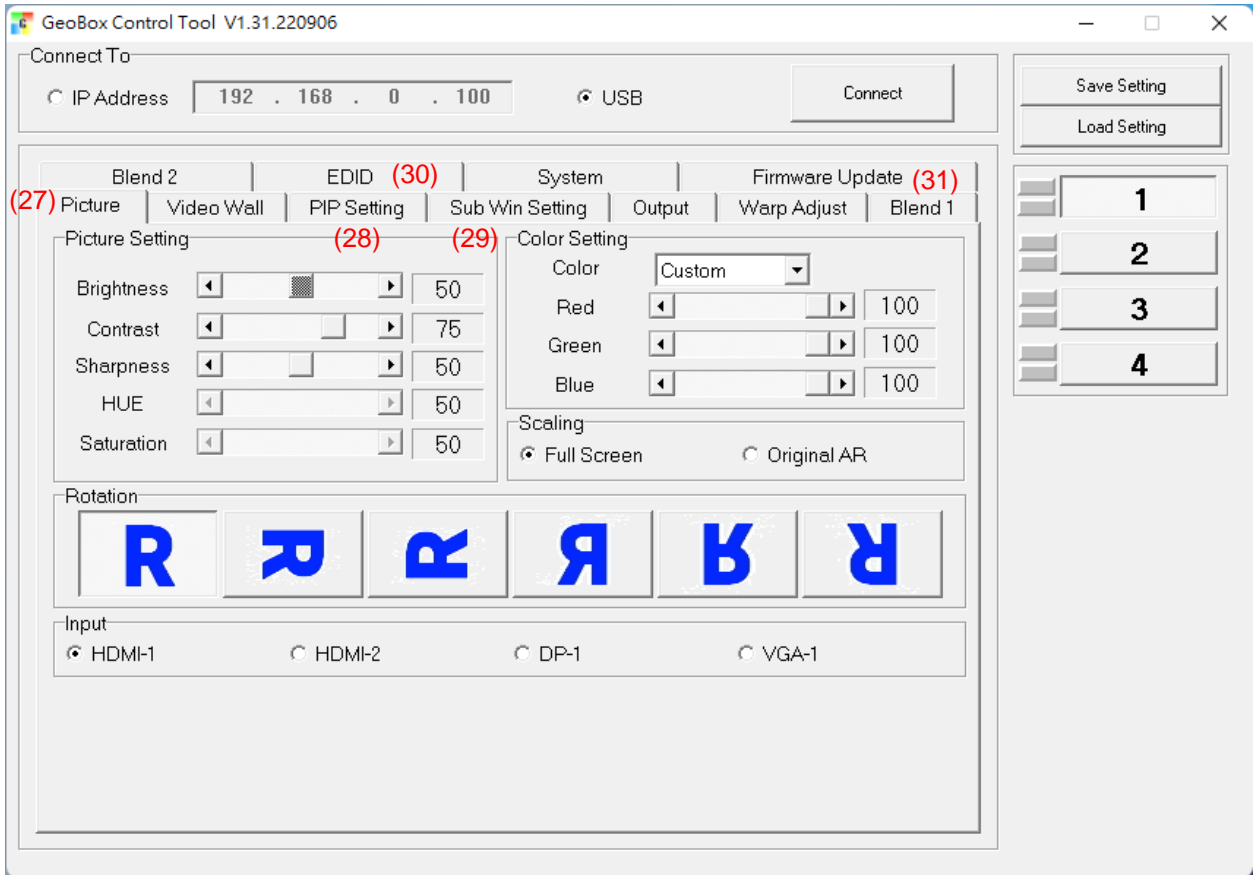

- (27) [Picture]: Input selection, image rotation, aspect ratio, color adjustment.
- (28) [PIP Setting]: select PIP/POP/3/4 split view types and set PIP size and location.
- (29) [Sub Win setting]: select sub-win signal source, rotation, aspect ratio and overlap setting
- (30) [EDID]: set EDID resolution for each input port
- (31) [Firmware update]: update firmware and MCU code. MCU code is for keypad and GCT control.

## 11. Advanced applications and settings

### 11.1. Passive 3D application

#### 11.1.1 System Configuration

GeoBox will decode 3D format from all kinds of 3D video sources, including Blue Ray DVD, STB, Media player, Game console and PC... 3D signal will be decoded by GeoBox into signals for Right/Left eyes. The signal needs to be displayed through two projectors. Each projector will display signal only for right eye or left eye. User needs to set a polarized filter in front of the projector and also wears polarized glasses. The glasses need to match the polarized filter in front of the projectors so that the right eye can only see the scene for right eye and the left eye can only see the scene for left eye. Silver 3D screen is also required to preserve the polarization of the light for 3D display. It is possible to use optic spectrum method from Infitec or Omega Optical to allow 3D displayed on normal 2D screen.

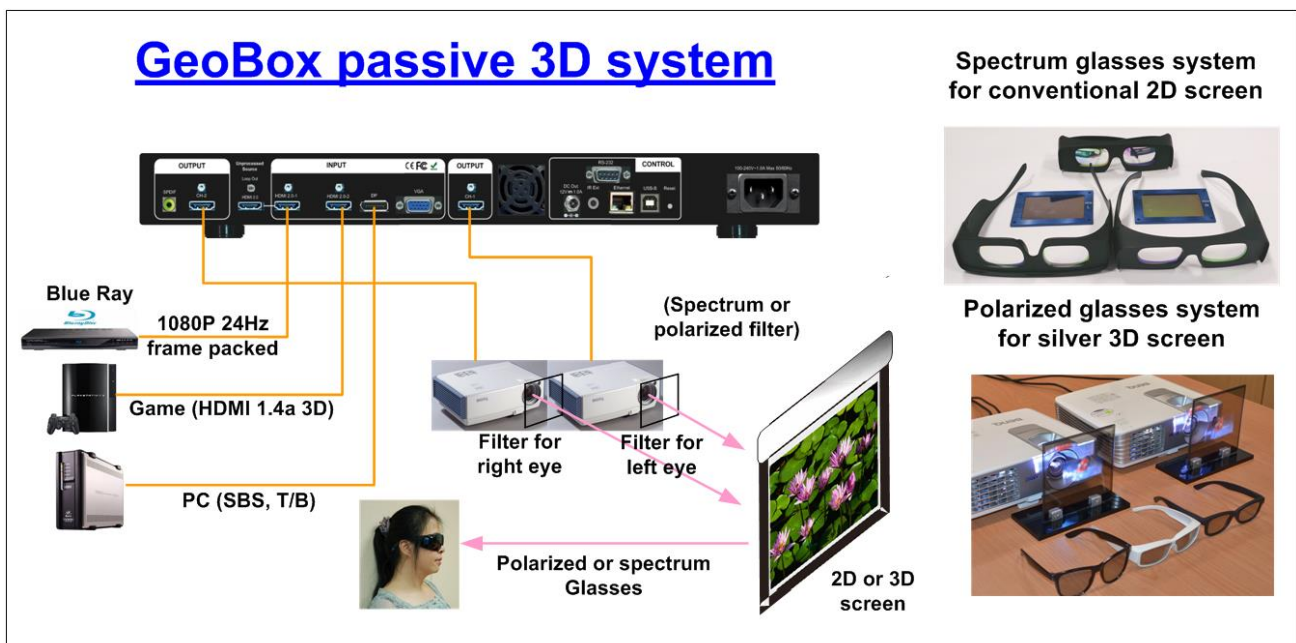

#### 11.1.2. System installation and setup

- a. GeoBox should not be installed at side of the projector where the ventilation hot air comes out.
- b. Two projectors can be put side by side or top/bottom. Closer position will reduce geometry adjustment range and reduce the loss of the image resolution and brightness. Please make sure hot ventilation air will not affect the other projectors. Isolated board between two projectors can be added if necessary.

- c. Set higher output resolutions (such as FHD) from 3D signal source and connect to any input of GeoBox. GeoBox will decode and distribute the signals for two projectors.
- d. Each GeoBox output is connected to one projector for right/left eye display.
- e. Install polarized filter at some distance from projector lens to avoid thermal damage (at least 5-10 cm depending on projector lumens).
- f. Setup the polarized filter and glasses so that right/left eye can only see the scene for one eye.
- g. Use geometry alignment function to align the images from two projectors completely matching together. Please place the polarized filter in front of the projector before [4 Corner] adjustment because polarized filter will affect the direction of light beam from projectors. Some deviation is allowed for 3D display but will affect the performance in 2D display. A good alignment will give double brightness for the projection in 2D display. For a good double brightness application, two projectors should be placed as close as possible and the screen must be flat or smooth curve.

### 11.1.3. GeoBox 3D settings

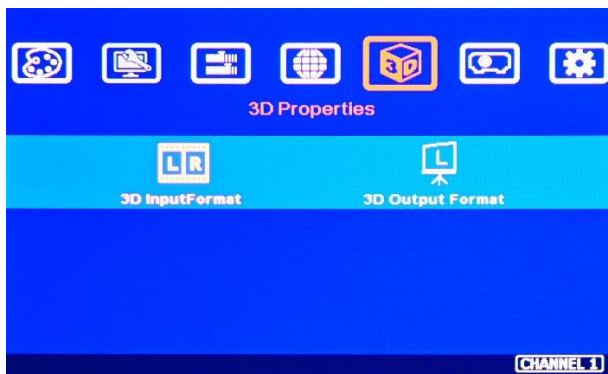

2 sub-menu under [3D Properties] menu

### 11.1.4. Input Format]

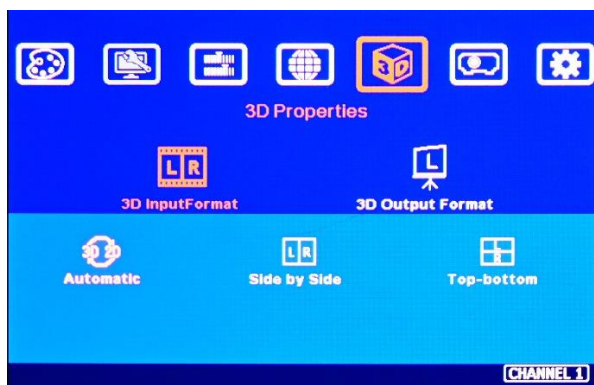

[Input Format] selection:

- ✓ Select [Automatic] if the 3D signal is standard 3D formats from Blue Ray player or sources with 3D INFO inside the signal.
- ✓ Select [Side By Side] or [Top-Bottom] based on user's 3D input sources.

### 11.1.5. [Output Format]

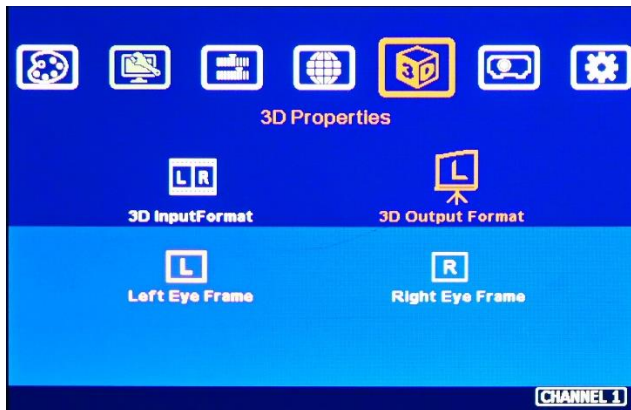

- ✓ To set [Right Eye Frame] for RH projector and [Left Eye Frame] for LH projector.
- ✓ [Output Fromat] setting is based on the filter location. If RH optical filter is installed at LH projector, then user needs to set LH projector at [Right Eye Frame]. User can swap [Output Format] setting to fix wrong position installation in optical filters.

## 11.2. Active 3D application

- User can support frame sequential 3D input signal and execute geometry alignment and edge blending for active 3D display system. Frame sequential 3D signal can be converted into 720p/XGA/WXGA 100Hz/120Hz or FHD 60Hz frame sequential 3D signal for DLPLink 3D Ready projectors. GeoBox can also apply geometry alignment for active 3D curved screen display. If user wants to implement active 3D edge blending, user can't use color wheel synchronization system in DLP 3D Ready system and needs to find a method for the synchronization of multiple projectors because the color wheel in multiple projectors can't be synchronized. The projector embedded with external synchronization signal function is one of the solutions to solve multiple projector synchronization issue.
- Other 3D formats such as side by side or DVD frame packed can't be converted into frame sequential 3D format for passive 3D display.

## 11.3. Multiple Wall Immersive display

User can use multiple projectors to execute Multiple Wall display with the images from different projectors. Below is the example for a display with 3 walls and one floor to build one immersive display.

### a. Assumption

- ✓ 3 walls display:  $W1=2m$ ,  $W2=5m$ ,  $W3=3m$
- ✓ Signal source: 3840x1200, GeoBox output resolution: 1920x1200

- ### b. Usually, 5000 Lum projector can cover 3-4 meters image width. Four projectors are required to cover entire screen.

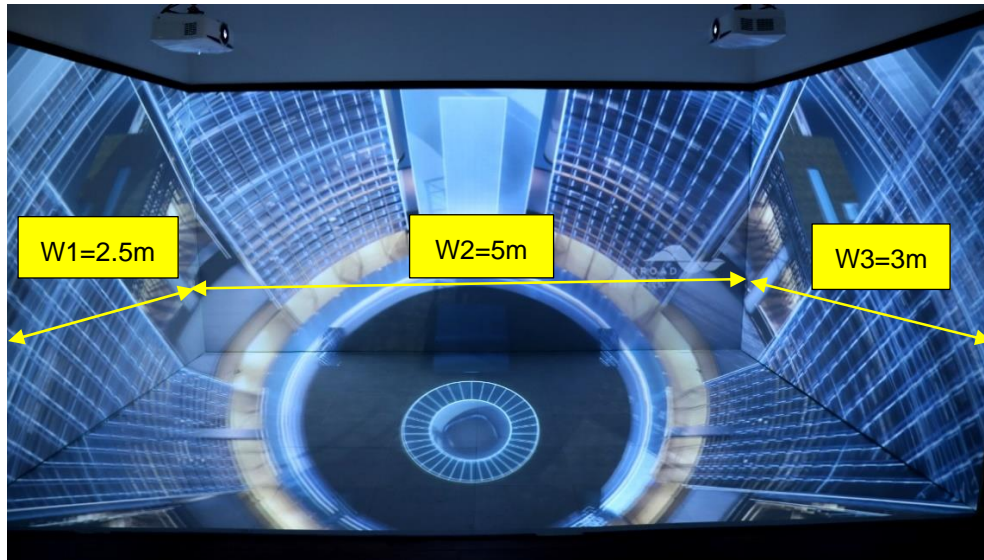

- c. The dimension of W1 is only 2.5m, it is possible using one projector to project onto W1 & W2. User needs to use [Corner Wall] or the geometry alignment. Due to big geometry alignment and off axle projection, the video quality will be lower. We suggest to meet the image edge at wall corner to get the best video quality.
- d. In ideal condition, each projector should have the same projection size to get equal brightness. For 2.5m image height, the image width should be 4m (16:10 aspect ratio).
- ✓ W1: one projector is enough
  - ✓ W2: require two projectors with edge blending to cover the space
  - ✓ W3: one projector is enough
  - ✓ Floor: 1-2 projectors is required. (If use one projector, the image size is 4.8mx3m, the brightness and resolution will be a little lower. The installation distance should be also considered. Bigger image requires bigger installation distance.
  - ✓ To let all projectors with the same scaling factor to avoid image size difference among the walls. Total screen dimensions:  $2.5+5+3=10.5\text{m}$
  - ✓ Total image width: 3840 pixels
  - ✓ Pixel density:  $3840/10.5= 366 \text{ pixels/m}$
  - ✓ Assign image resolution for each wall to get the same scaling factor.
    - W1 (PJ1)  $=366*2.5= 914 \text{ pixels (Projector \#1)}$
    - W2 (PJ2 & PJ3)  $=366*5= 1829 \text{ pixels (Projector \#2 \& \#3)}$
    - W3 (PJ4)  $=366*3= 1097 \text{ pixels (Projector \#4)}$
    - Based on the above data, if we express the image location by coordinate, W1 is from 0 to 914, W2 is from 914 to 2743 ( $914+1829$ ), W3 is from 2743 to 3840.
- e. Video Wall settings:
- User can set different Video Wall Zoom value for each projector separately. We assume to set Zoom at H=4, V=1 for all projectors.

- ✓ W1: Zoom: H=4, V=1, Pan: H=1, V=1  
Overlap:  $3840/4=960$ ,  $914-960= -46$  → Right Edge = -46, Other Edge=0
- ✓ W3: Zoom: H=4, V=1, Pan: H=3, V=1,  
Overlap:  $3840/4=960$ ,  $1097-960= +137$  → Left Edge = +137, Other Edge=0
- ✓ W2: The image captured for W2 is 1829. User needs to calculate Video Wall Overlap Pixel based on this resolution. If we want to get 2.5m image height, we need to have 1440 overlap pixels, the overlap value is 549 pixels.

Source resolution (H)	1829	Screen width	5.00	(m)
Source resolution (V)	1200	Screen height	2.50	(m)
Projector resolu. (H)	1920	Projector lumen	6000	(Lum)
Projector resolu. (V)	1200	Screen Aspect ratio	2.00	(required)
Overlap pixels (32 pixels per grid)		Overlap %	Recommended	
Overlap pixel (H)	1440	75.0%	20%~40%	
Overlap pixel (V)	0	0.0%	25%~40%	
Recommended overlap region: Min. 50 cm width				
Qty of projector (H)	2	Throw ratio (Min)	0.50	
Qty of projector (V)	1	Throw ratio (Max)	0.80	
Final output resolution		* Please apply Overlap pixels with 32x because default grid size for geometry adjustment is based 32x32 for each grid.		
Horizontal resolution	2400	*User can change grid size via OSD to any grid size between 8-120 pixels.		
Vertical resolution	1200			
Extended pixel (H)	549			
Extended pixel (V)	0			

Final Image size (meter)		Final Illuminance Lux (Lum/m2)		Image size for each PJT	
Width	5.00	PJT lumen	6000	Width (m)	4.000
Height	2.50	Final Illumin	600	Height (m)	2.500

Overlap region size		Original aspect ratio		Projector throw distance	
Horiz. (m)	3.000	Projector	1.60	Min (m)	Max (m)
Vertic. (m)	0.000	Final result	2.00	2.00	3.20

\* Final image height should be equal or larger than screen. User can shrink image to have the same image height as screen by GeoBox geometry adjustment.

\* Standard luminance is 400-800 Lux for restaurant and big conference room, 1000-1500 Lux for trade show. 3D: 500 Lux (single projector)

\* Theater: 172 Lux (16 foot-lamberts), SMPTE display standard: 377 Lux

\* Final brightness of the screen needs to multiple gain value of the screen.

\* The actual installation image size should be equal or larger than expected size.

\* The best content resolution is the same as Final output resolution in cell D15& D16.

Video wall setting value

Position of projector (H)	1	2	3	4	5	6	7	8	9	10
LH edge overlap value	0	549	x	x	x	x	x	x	x	x
RH edge overlap value	549	0	x	x	x	x	x	x	x	x

- ✓ Under this condition, the image cropped for PJ2 should be in the range from coordinate 914 to 2377.5 ( $914+1829/2+549$ ). The image for PJ3 should be in the range from coordinate 1279.5( $914+1829/2-549$ ) to 2743 ( $914+1829=2743$ ).
- ✓ PJ2 Video wall setting: Zoom: H=4, V=1, Pan: H=2, V=1. The standard coordinate after Zoom setting will be from 960 ( $3840/4$ ) to 1920 ( $960*2$ ), Overlap value will be: Left Edge:  $960-914= 46$ , Right Edge:  $2377.5-1920= 457.5$  (actual 457 or 458)
- ✓ PJ3 Video wall setting: Zoom: H=4, V=1, Pan: H=3, V=1. The standard coordinate after Zoom setting will be from  $960*2=1920$  to  $960*3=2880$ , Overlap value will be: Left Edge:  $1920-1279.5= 640.5$  (actual 640 or 641), Right Edge:  $2743-2880= -137$
- ✓ After Zoom and Pan settings, user can also apply external Video wall test pattern and align the image together through Overlap adjustment. Once the pattern can match together, the Overlap settings should be correct. When apply external test pattern, user needs to continuously press [Pattern] key to see the test pattern.
- ✓ After finishing video wall settings, user needs to set [Edge Blend] between PJ2 and PJ3 to finish complete system settings.

## 11.4. Portrait edge blending

When executing edge blending, the image will be stretched and the aspect ratio will be changed. In order to reduce aspect ratio change, user can execute portrait edge blending to increase image height. When execute image 90/270 degrees rotation, the input source resolution can be up to 4k/30Hz.

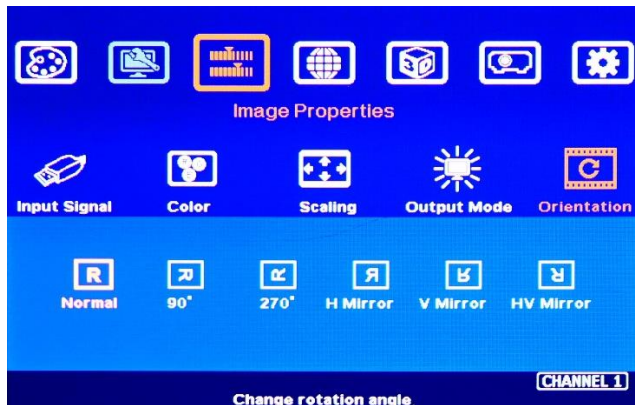

- Projector at portrait position to increase image height
- Source image is rotated by GeoBox at 90°
- Zoom: H=3, V=1 in all projectors
- PAN settings are showed in each image.
- Overlap settings: PJ1: Right Edge, PJ2: Left Edge & Right Edge, PJ3: Left Edge

- Some projectors are not suitable to be installed at portrait location. Laser projector has high contrast ratio, no limitation in installation angle and accurate color and gamma curve. It is the best choice for edge blending application.
- G810 can rotate source image before edge blending. It will be more convenient for user to connect with all kinds of conventional signals without the need to rotate the image in advance.
- When apply portrait edge blending, the VNS Excel Spread Sheet calculation also needs to change the output resolution. If the projector is 1920x1200, then user needs to key-in Output Resolution (projector resolution) at 1200x1920.
- The OSD menu will not follow rotated image. Video Wall setting direction will follow actual rotated image direction but not OSD direction.
- All the function settings under [Anyplace] menu will follow OSD menu directions but not follow rotated image direction. The items include geometry alignment & edge blending.

- Except for the directions, all the rest settings will be the same as normal display.
- Image rotation menu is under [Image Properties]

PS1. If using Fujifilm projectors with rotatable lens to project all-in-one image on Ceiling, wall and floor, the location setting (PAN) at 1<sup>st</sup> and 3<sup>rd</sup> projectors may be swapped. Please see the image after rotation and Left side projector PAN is H=1.

PS2. When apply portrait edge blending, the installation location of the projector will be near the middle height of the screen. If the projector has lens shift function, projector can be installed at higher location.

## 11.5. **Flexible display**

- When edge blending is implemented, the image aspect ratio will be changed.
- If the content has the same aspect ratio as the screen, the system can be setup to show no distortion image.
- In order to reserve flexibility for different user environments, GeoBox allows user to set different display modes. Below is the example for 3 projector edge blending system.
  - Case A: All-in-one: display one content across entire screen.
  - Case B: 2+1: two projectors edge blended and one independent content display.
  - Case C: 1+1+1: Each projector displays independent content.
  - Case D: display one 16:9 image
- GeoBox setting for each case:
  - Case A: it is normal edge blending setting. Save the setting to Profile Index 1.
  - Case B: To reset all settings, select the input sources for discrete display and implement edge blending only on two projectors. Save the setting to Profile Index 2.
  - Case C: To reset all settings, select the input sources for discrete display and implement geometry alignment to separate the images among all projectors without overlap. Save the setting to Profile Index 3.
  - Case D: To reset all settings, execute edge blending for two projectors only. Using geometry alignment to draw the image with 16:9 aspect ratio.

Note 1. G810 two output channels from the same processing module will share the same input port. If user wants to display different contents in these two outputs, user shall select from below combinations: HDMI+VGA, HDMI+DP or DP+VGA

Note 2. please save the setting through Remote controller "SAVE" hotkey or PC tool so that all channels can be saved into the same Profile Index for easy recall. User can recall through remote controller, RS232 or Ethernet. No projector installation or setting change is required.



## 11.6. Discrete content displayed in each projector

User can configure to show independent content in each projector. Below are the guidelines:

- Signal source selection: only one HDMI input source can be selected as discrete display input source in one processing module. User shall select from below combinations: HDMI+VGA, HDMI+DP or DP+VGA. It means one G814 can provide two HDMI signals and the rest shall be from VGA or DP.
- When execute discrete display, please reset [Video Wall] and Edge Blend] to default value.
- User need to use geometry alignment to let the images in projectors apart from each other.
- The Overlap region among adjacent projectors should not be too big. Otherwise, the final discrete image will have more aspect ratio change due to draw the image inward. If necessary, user can draw back top/bottom image by Video Wall [Overlap] function to let final image has the same aspect ratio as original.
- Save the final result into the same Profile Index in all processing modules for easy recall.

## 12. System Structure and Control

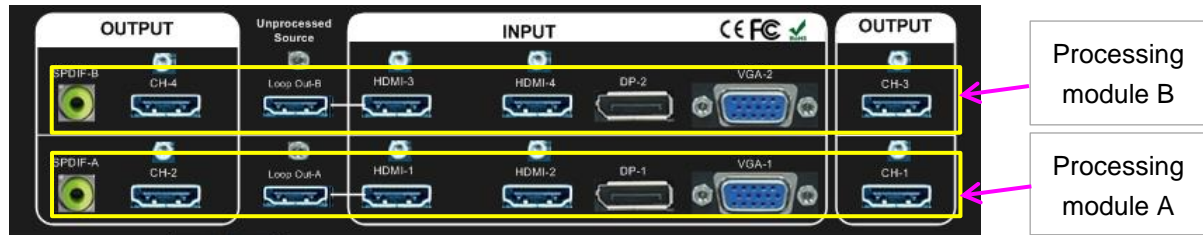

### 12.1. System Structure

- G814 consists of two G812 processing modules. It can serve as one 4 channel processor or two dual channel processors.
- The input port in each processing module is independent and only for the same processing module. If user wants to feed two processing modules with the same signal, the input signal shall come from HDMI-1 or HDMI-3 then link to next module through HDMI Loop out port.
- HDMI-1 & HDMI-2 (or HDMI-3 & HDMI-4) input signals will go through the same HDMI switcher. User can only select either one for system display.
- For discrete display in each projector, user can't display HDMI-1 & HDMI-2 (or HDMI-3 & HDMI-4) signals to both output channels in the same processing module but user can select HDMI+VGA, HDMI+ DP or VGA + DP to display independent contents in each projector.

### 12.2. OSD command executing in both modules at the same time

- [Options]→ [Setting]→ [Box ID], only can be setup via CH-1 or CH-2.
- [Options]→ [Setting]→[Network], only can be setup via CH-1 or CH-2
- [Options]→ [Setting]→[Profile]→[Save], via remote controller
- [Options]→ [Setting]→[Profile]→[Load], via remote controller

### 12.3. OSD Command Executing in each processing module

- Below command will be applied to 2 channels in the same module at the same time.
  - [Image Properties]→ [Scaling]: select full screen or original aspect ratio
  - [Image Properties]→ [Output Mode]: select output resolution
  - [Profile]→ [Load]→ [Index]
  - [Options]→ [Language]: select OSD language
  - [Options]→ [Reset]
  - [Options]→ [Accessibility]→[OSD Time Out]
  - [Options]→ [Accessibility]→[Logo Time Out]

- [Options]→ [Accessibility]→[Standby Time]
- [Options]→ [Accessibility]→[Black Screen]
- [Options]→ [Setting]→[Mute]
- [Options]→ [Setting]→[Profile]→[Save], via OSD menu
- [Options]→ [Setting]→[Profile]→[Load], via OSD menu
- The following commands will be applied to each output channel separately.
  - Color adjustment: All menu under [Picture]
  - All items under [Anyplace]
  - All items under [Video Wall]
  - [Image Properties]→ [ Color]
  - [Image Properties]→ [Input Signal]
  - [Image Properties]→ [Orientation]
  - [Options]→ [Information]: show system information

## 13. Miscellaneous settings

### 13.1. Helpful tips for edge blending

- G810 can support interlaced signal source (i.e. 1080i). However, if user rotates or flips the image, there will be no 3D motion adaptive de-interlaced function. User may see some small flick image while the input is still image. We recommend applying progressive signal to avoid this kind of issue.
- In the application with short throw ratio projector on curved screen, there will be big image distortion. User needs to apply big geometry alignment and degrade the video quality.
- Image position drift will cause blurred image in overlapped region. For edge blending application, please select one projector with less Thermal drift. It can be judge through comparing image position shift between Power on and after 20 minutes running time.
- Mark the final image position. Once the position shift in the future, it can be recovered through [2x2] corner adjustment via remote controller easily.
- Native contrast ratio is important in edge blending. The higher contrast ratio will have less light leakage with less banding in overlapped region under dark environment.
- Ultra-short throw projector is not suitable for edge blending due to big reflection angle and easy to cause color banding effect while watching from different viewing angle, especially under high gain screen.
- Select projector models for edge blending in advance will make sure to get the best final quality.
- DLP Laser projector is good for edge blending under dark environment. LCD projector has good color saturation and is suitable for multimedia application at normal ambient light environment.
- During system settings, the output signal may be temporarily lost and cause projector re-searching input signal and the image disappears shortly. User can disable [Frame Sync] function to avoid this kind of effect. After finishing system setup, user need to set [Frame Sync] at [Normal] position to get perfect synchronization in all output channels.

### 13.2. Image distortion

- If the content aspect ratio is different from the screen aspect ratio, it will cause image distortion. User has below alternatives:
  - User can adjust aspect ratio through video wall [Overlap] settings.
  - Full screen display but some content will be drawn to outside border and missing.
  - Draw the image into screen and keep some blanking border at some borders.
- If the content aspect ratio is the same as screen aspect ratio, user can take below actions to get no distortion full screen display through below actions:
  - If the signal source is from PC, user can set EDID resolution with the same aspect ratio as the screen.

- If the signal source output resolution is not the same aspect ratio as the screen, user needs to set signal playback with full screen display but not keep original aspect ratio.
- In PC display card settings, user needs to select [Full screen] display but not [Keep original aspect ratio]. GeoBox will expand the image to full screen automatically.

### 13.3. EDID Setting

Selective EDID setting for input source resolution is added into GeoBox. The settings will be applied to individual processing module on select input port. Each processing module needs to set EDID separately. Below are some guideline for EDID setting:

- GeoBox can support big range of input signal timing—from XGA up to 8k/2k @30Hz. In order to get the best video performance, user needs to select the best input signal resolution.
- Different source resolution may show different final image aspect ratio. User can utilize different EDID setting to change signal source timing and get different output aspect ratio.
- User can select different EDID directly from OSD list or use [Customize] function to create Non-VESA standard timing.
- If the signal is from PC, user can set customized EDID in GeoBox to let PC output expected resolution. Some PC may not follow GeoBox EDID resolution setting and require customized output setting from display card or re-boot.
- User can create some timings that is outside VESA standard, such as 7680x2160/30Hz.
- PC or laptop may not output required timings due to hardware limitation or driver issue. User may need to do custom setting inside PC and re-boot to get desired output.
- The optimized EDID resolution should be the final resolution after edge blending. For instance, if user uses three WXGA projectors for edge blending with 320 overlapped pixels, then the best signal for this setup will be  $1280*3-320*2=3200$ .
- PC may memory the first EDID when it is connected with GeoBox. Some PC may not follow new EDID setting in GeoBox. Below are some suggestions that may fix this kind of issue.
  - Power ON GeoBox first and set EDID before connected with signal source. It will make sure PC can catch correct EDID information.
  - Please use [Customize] EDID setting. This setting is from PC VESA standard and good for some PC display card. It may give much clear image for PC source. Some preset EDID modes are CEA standard and have minor difference with PC in signal details.
  - Disconnect signal source while set EDID. It will avoid interference from signal source and get correct EDID settings.
  - In some case, deep EDID reset from Factory setting mode may solve some EDID issue. Please insert small pin into Reset hole for 5 times with 1 second interval, user will see OSD menu with “F” text at the top left. Use direction key to select “F” and press [Enter] to get into

Factory setting mode. Inside factory setting mode, user can select [EDID Write] and press [Enter] to do EDID reset. After see PASS, then back to [Exit] to close OSD window.

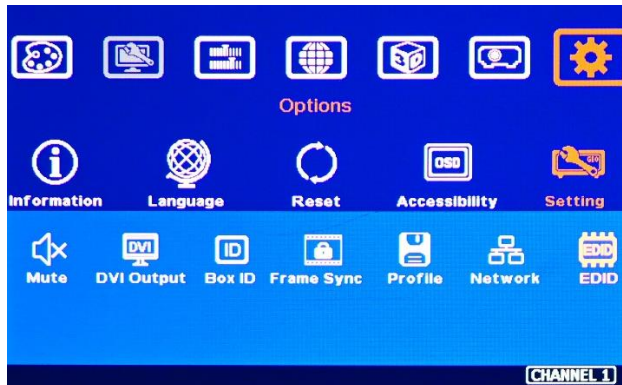

- Activate EDID setting menu: [Options]→ [Setting]→ [EDID]
- Use IR remote controller to select desired EDID.
- After select EDID, signal source will auto-change the output timing setting.
- Press [INFO] key to check if the input and output timing are set correctly.



- User can also set EDID manually. The range for customized EDID will be from 1024x768 to 3840x2400.
- Horizontal resolution is in a step of 8 pixels and vertical resolution is in 1-pixel.
- After creating the EDID, PC or laptop may not output required timings due to hardware limitation or driver issue. User may need to do custom setting inside PC and re-boot to get desired output.

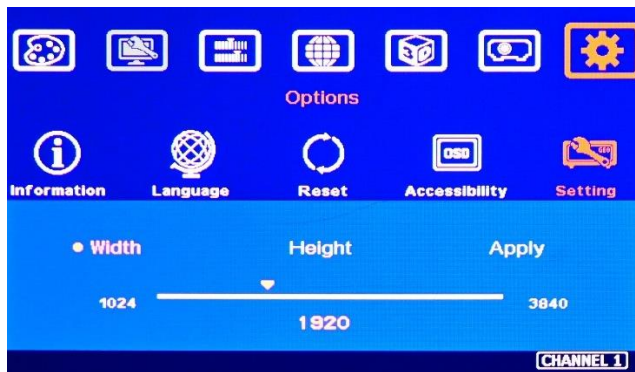

### 13.4. HDMI vs. DVI Output Signal

- HDMI digital signal is compatible with DVI signal. Most of display devices can support both digital signals. However, some old equipment may have less flexibility in signal compatibility. In this case, user may need to select DVI output format to get normal display in some devices.
- HDMI signal embeds more signal information, such as color space, color sampling, aspect ratio audio and HDCP. Once some information is missing, it will also affect the display. It may cause intermittent or loss of image. Under this condition, user can try to set DVI output. The connection doesn't need to change.



### 13.5. System Standby and Automatically Turn Off Output Signal

- [Options]→ [Accessibility]→[Standby Time]
- If set [Standby Time] at 60, the system will get into Standby Mode after 60 seconds when no input signal is detected. The output signals from G814 will also be terminated at the same time. If G814 detects input signal again (hot plug signal), it will automatically turn on the system.
- If the projector can automatically turn off/on by detecting input signal, user can control signal source to execute entire system on/off control.

### 13.6. Change Background Color

When no signal input, the system will show blue color background with [Power Saving Mode] message on the screen. User can change background color to black on the screen without text message on it through [Options]→ [Accessibility]→ Black Screen]→ [On]

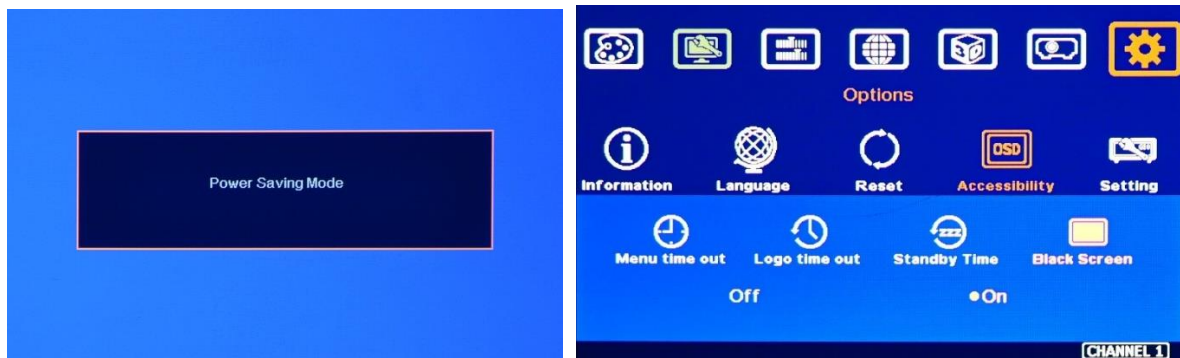

### 13.7. Turn off splash screen Logo

- User can turn off splash screen Logo through [Options]→ [Accessibility]→ [Logo Time Out] and set the value at "0". Default setting is 10 seconds.
- It will reduce the boot up time.

### 13.8. **Limitations in Image Flip and Rotation**

Image 90/270 degrees image rotation is only available in input resolution under 4k/2k @30Hz (included). While image is rotated or flipped, there will be no 3D motion adaptive de-interlaced function. We recommend apply progressive source signal to get the best video quality.

## 14. **Trouble Shooting**

### 14.1. **Front Panel LED indicators**

- User should see Input / Output LED lights in each channel. If no light illuminated in specific channel, please check Input / Output connecting cables, signal source & monitor in that channel.
- If user sees continuous flashing in some channel LED, it means OSD may be locked. Please press [Menu] key for 5 seconds or press 850 number keys in remote controller to disable [OSD locked].
- If user sees flashing LED on Input/Output LED indicators at the same time with 1 second interval, it means the system gets wrong FW/MCU code or HW failure. User can turn off/on the system again to see if it can solve the issue. User can also update the MCU code and FW through GUU PC tool. If the issue is still existing, user needs to apply RMA and send back the unit to factory for checking.

### 14.2. **No image in the projector**

- If user can't see the image, please click [Menu] key to activate OSD. If user can see normal OSD, the system should be normal. Please click [INFO] key to check input and output timings.
- If user can't see the OSD, please change signal source, HDMI cable or display device to find the root cause of the failure.
- HDCP may be the reason for no image. Please make sure display device is HDCP compliant.

### 14.3. **Intermittent or Loss of Input Signal**

- Check the HDMI cable quality and make sure all cables are fitted correctly. 4k/60 signal requires high speed certified cables.
- Cable length: Connecting cable length should be as short as possible. Replace a short cable to verify the possible root cause.
- HDCP compliant issues: If the input source or the monitors are not HDCP compliant, it is possible to stop GeoBox from negotiating HDCP link and show intermittent, abnormal or no image. Please check HDCP condition in signal source or display device.
- Resolution issues: check if signal source and connecting cables can provide source signal supported by GeoBox.
- DVI/HDMI signal compatibility: some display devices may only support HDMI or DVI video signal

and execute wrong signal format detecting. The default output is HDMI. User can change output with DVI format through [Options]→ [Setting]→ [DVI]→ [On].

- Usually, to swap with different cable, output channel, signal source and projector can verify the root cause for the failure.
- It is possible to have signal compatibility issue. User can add one HDMI splitter/switcher in the middle to change signal impedance. It may fix the issue.
- We propose to use signal enhanced cable, HDBaseT or Optical Fiber cable for long distance connection. Conventional 4k/60 HDMI can't support more than 10 meters.
- User can connect a monitor at the end of the Loop out port to check signal source stability.
- During system settings, the output signal may be temporarily lost and cause projector re-searching input signal and the image disappears shortly. User can disable [Frame Sync] function to avoid this kind of effect. After finishing system setup, user need to set [Frame Sync] at [Normal] position to get perfect synchronization in all output channels.

#### **14.4. Video quality issues**

- Try to use the highest signal resolution and number of color bits (RGB 4:4:4) allowed by GeoBox. Please click INFO key to verify input/output resolution.
- There are a number of lower-quality AV players, the specification and actual output are difference. These media player may be designed with lower color sampling bits or poor image compression technology, resulting lower image quality or lagged image.
- If the use of H.264/H.265 compressed files, please select a player with hardware decoding to get smooth video quality.
- If the input signal is interlaced signal (interlaced-1080i), and the image is rotated, then the channel will have no [3D Motion adaptive de-interlaced] processing function. If user applies static image source, the output video may have slight jitter phenomenon. The processing channel quality will be reduced. Use a progressive signal source setting (1080p/2160p) whenever it is possible.
- Please press [INFO] shortcut key to check the input/output signal settings.
- User can select [Image Properties]→ [Output]→ [Deep Color] to set 10-bit signal output. It will smooth the gradient color when the input signal is also 10-bit. Please note that HDMI 2.0 can only support 4k/2k 60Hz 8-bit signal only.
- If possible, please apply 60Hz signal source. User can see smoother image while image is panning or in fast motion. User may see jitter image in 24/30Hz input source.
- Please press [INFO] shortcut key to check the input/output signal settings.

## 14.5. Image position shift after installation

The position shift in the projector will be enlarged to more than 10x due to projection distance. 1 mm image shift inside projector may appear 1 cm image shift on the screen. User will clearly see blurred effect on overlap region in edge blending setup.

- There will be some image position shift after system setup. The main reasons are as follows:
  - Thermal drift due to projector internal temperature change. The image position in projector power on stage and after 20-30 minutes may have big difference. Different projector will have different thermal drift range.
  - Stability of rack mounting system.
  - Projector structure change after installation due to weight and thermal effect.
  - Cable connection and cause weight balance issue.
  - Change lamp.
  - Earth quake or caused by human reasons.
- The first projector image position calibration should be done within one month after installation. The second calibration may be required after 3 months, then every 6 months or once a year.
- If user finds big position shift and doesn't know the real issue. Please follow below procedures to confirm the issue is from GeoBox or not.
  - Turn off GeoBox and open projector internal test pattern.
  - Mark the corner positions of the projector image and overlap region borders.
  - Check projector image shift condition after some time with GeoBox in OFF condition.
  - User will clearly identify that the position shift is from GeoBox or not after this procedure.
  - GeoBox is digital processor and will not change image position only for few pixels.
- Please open test patterns in GeoBox before edge blending and put marks on 4 corners of each projector as reference for future image position recovery by [2x2] alignment.

## 14.6. System crash and malfunction

- After FW update, please reset the system through a pin inserting to reset hole on the back panel for 5 seconds to avoid abnormal settings inside the system.
- Image 90/270 degrees rotation can only be executed under 4k/2k @30Hz input resolution.
- When the input source is 4:4:4 PC graphics signal, only [Brightness], [Contrast] and [Sharpness] three items under [Picture] menu can be executed. If the input is 4:2:2 video source, all the items are functional.
- When implement [Corner Wall] alignment, other geometry functions will be not functional.
- Remote controller may be interfered by environment and can't be smoothly operation.
- When geometry alignment is over the maximum adjusting range, the system may crash. It can be recovered by system reset.

## 14.7. Synchronization issue in the outputs

- The input refresh rate should be the same as output refresh rate so that the system can implement Frame Lock to synchronize all the outputs. If the input source is 50Hz with 60Hz output, it is possible to see some lag or frame tear in the display.
- 30Hz input with 60Hz output will be OK.
- Please make sure to set [Frame Sync] at [Normal] in all channels to ensure all outputs will be synchronized.

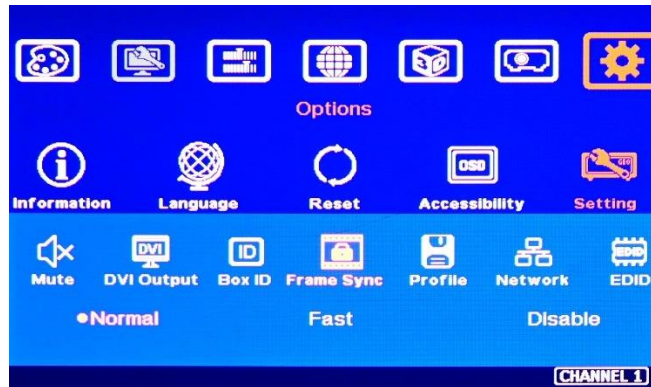

## 14.8. How to reduce projector re-searching input source

User can set [Frame Sync] at [Disable] to reduce [Source Re-search] in projector during setup. After finish the setup, please set to [Normal] to get synchronization in all outputs.

## 15. Technical support

- User can send e-mail to [sales@vnstw.com](mailto:sales@vnstw.com) together with as much information as possible.
- The following information is required for a swift response.
  - Sink device (projector): type and model number
  - Screen details or specific application details.
  - GeoBox model No. and series No.
  - Details of the signal source and the resolution.
  - Press [Info] key to get System Information and send the data to us, including input/output timing and F/W version.
  - The exact nature of the problem. Please be as detailed as possible.
  - If possible, please attach the Pictures of the issue.
- Generally, we will response within 24 hours (excluding weekends)
- Please note that if the machine is sent back for repair, user needs to pay for the delivery cost.

## **16. Safety Precaution and Maintenance**

### **16.1. Power Supply**

Please connect electric power for all devices in the system from the same Power Distribution Box with correct grounding. Open the power after finishing system connection to reduce the risk for system damage from high floating voltage.

### **16.2. Working Environment**

Please locate G814 in an environment free from dust, moisture and high temperature with good ventilation.

### **16.3. Warranty**

This device is designed and tested to the highest standards and backed by two years' parts and labor warranty. Warranties are effective upon the first delivery date to the end customer and are non-transferable. Warranty period extension is available up to 5 years through paying extra charges.

### **16.4. Maintenance and Repair**

Apart from what is detailed in User Guide, maintenance should be carried out by competent technician assigned by VNS. If G814 is physically damaged, it should be returned for repair using VNS RMA procedures. If the unit is opened by user, it will lose the right for warranty protection.

## **Specification**

- ✧ G812: single processing model, G814: dual processing models
- ✧ Each processing module: Input: 2x HDMI 2.0b, 1x DP1.2a, 1x VGA.
- ✧ HDCP: HDMI V2.2/V1.4, DP: HDCP: V1.3.
- ✧ Max. input resolution: 4096x2160 @60Hz, 7680\*1200 @30Hz.
- ✧ Support non-VESA standard input timings.
- ✧ Output: G812: 2x HDMI, G814: 4x HDMI, up to 2048x1080 @60Hz & WUXGA.
- ✧ Input / Output signal is 10 bits, 4:4:4 chroma sampling. Input support RGB/YUV progressive and interlaced signals. Output is progressive RGB.
- ✧ G812: 1x HDMI 2.0b loop out ports for multiple unit daisy chain connection. G814: 2x HDMI loop out.
- ✧ Warp engine for geometry alignment up to 17\*9 control points in IR control and GCT PC Tool.
- ✧ 120x68 grid pixel position fine-tune. Each control point can be adjusted with 1/4 pixel/step and moved up to 12.5 pixels adjustment range. Maximum adjusting points are 100 points.
- ✧ Geometry adjustment range up to 600 pixels in both H&V directions.
- ✧ Two frame latency: 33ms (at V=60Hz)
- ✧ Edge blending at 4 edges up to H= 1920 pixels, V=1200 pixels with independent RGB gamma correction and 9 area black level uplift.
- ✧ Support “W” type Corner Wall adjustment in H&V at flexible location with the same image scaling factor. The adjustment range in 4 corners, horizontal / vertical and curve point are 1200 pixels each.
- ✧ Support Linearity Grid Line adjustment for quick H&V line position alignment via remote controller.
- ✧ Edge Mask up to 500 pixels following the result of geometry alignment.
- ✧ Edge Mask up to 900 pixels in H&V directions through 8 control points around image border.
- ✧ Embedded full function video wall function for image split, cropping and overlap pixel setting.
- ✧ 15 preset output resolution up to 2048\*1080 @60Hz. Support refresh rate 24/30/50/60/120 in some output timings.
- ✧ Input support xvYCC & 8/10/12-bit deep color processing.
- ✧ System settings can be stored and backup.
- ✧ Selectable grid pattern size from 8-120 pixels in H&V direction. Default is 32\*32 pixels.
- ✧ 50Hz in/out & frame rate conversion.
- ✧ Selectable grid pattern color and with optional transparency to see background image.
- ✧ Flexible aspect ratio adjustment in each edge up to +- 1800 pixels cropping range.
- ✧ 10-bit processor, 3:2/2:2 cadence, low angle smooth algorithm, high quality scaling engine.
- ✧ 3D motion adaptive de-interlace.
- ✧ Frame lock for multiple channel synchronized outputs.
- ✧ Support HDR input signal but no HDR effect in the output.
- ✧ Individual color and white balance adjustment in each output channel.
- ✧ Individual 90/180/270 rotation, flip, cropping, scaling & color adjustment in each channel
- ✧ 90/270 degrees rotation and flip only available under 4k/30Hz input resolution.

- ✧ Embedded HDMI & SPDIF audio outputs
- ✧ Selectable and programmable EDID in the range: H=1024-3840, V=720-2400.
- ✧ ESD Protection:  $\pm 8\text{kV}$  (Air-gap discharge),  $\pm 4\text{kV}$  (Contact discharge)
- ✧ Dual power supply in G810. User can use either AC 100-240V or DC 12V power supply. When use AC power supply, there is a DC 12V 1A output for signal extender.
- ✧ Power consumption:
  - Without DC12V/1A output: G812: AC 240V, 0.05A/11.9W, 110V: 0.106A/11.7W, G814: AC240V 0.139A/33.4W, AC110V: 0.295A/32.5W
  - With DC12V/1A output: G812: AC 240V: 0.10A/23.9W, 110V: 0.215A/23.7W, G814: AC240V: 0.139A/33.4W, AC110V: 0.295A/32.5W
- ✧ Working environment: 45° C, 10-90% RH
- ✧ Control: IR, RS232, WebGui & PC tool for USB & Ethernet
- ✧ Dimensions (Body only): G812: 440mm\*161mm\*44mm, G814: 440mm\*172mm\*58mm
- ✧ Weight: G812: 2.10 kg, G814: 2.46kg (body only)
- ✧ CE/FCC/RoHS Certified
- ✧ 2 Year Warranty, paid extension available up to 5 years.

**Revision History**

Revision	Date	Originator	Comments
V1.00	2023-0814	Steve Wang	First version
V2.00	2024-1209	Steve Wang	Typo review